



**R. C. TRASMISSIONI S.R.L.**

# **R. C. TRASMISSIONI S.R.L.**

**Sede e deposito centrale: 21020 BUGUGGIATE (Va) - Via Rossini, 13**

**Tel. 0332.457.222 (r.a.) - Fax 0332.890.186**

**40011 BOLOGNA / Anzola dell'Emilia - Via I° Maggio, 10 - Tel. 051.735.290 - Fax 051.735.366**

**20156 MILANO - Via E. Cantoni, 3 - Tel. 02.33.400.947 - Fax 02.33.400.949**

**35127 PADOVA - Via Portogallo, 11 int. 73 - Tel. 049.87.05.184 - Fax 049.87.00.037**

**10148 TORINO - Via G. B. Lulli, 61H - Tel. 011.22.67.146 - Fax 011.22.66.925**

**Filiali estere:**

## **R. C. TRASMISSIONI ESPAÑA S.L.**

**Poligono Industrial La Gavarra**

**c/Purgatori, n°10 - 08540 CENTELLES - ESPAÑA - Ph. 0034 93 8440099 - Fax 0034 93 8442193**



## **INDICE**

<b>Tabella dimensione gole trapezoidali</b>	<b>pag. 2</b>
<b>Forme costruttive pulegge per bussola conica</b>	<b>pag. 3</b>
<b>Pulegge sezione SPZ per bussola conica</b>	<b>pag. 4÷6</b>
<b>Pulegge sezione SPA per bussola conica</b>	<b>pag. 7÷9</b>
<b>Pulegge sezione SPB per bussola conica</b>	<b>pag. 10÷12</b>
<b>Pulegge sezione SPC per bussola conica</b>	<b>pag. 13 -14</b>
<b>Pulegge sezione SPA con mozzo pieno</b>	<b>pag. 15 -16</b>
<b>Pulegge sezione SPB con mozzo pieno</b>	<b>pag. 17÷19</b>
<b>Pulegge sezione SPC con mozzo pieno</b>	<b>pag. 20 -21</b>
<b>Pulegge sezione SPA per calettatori</b>	<b>pag. 22÷24</b>
<b>Pulegge sezione SPB per calettatori</b>	<b>pag. 25÷27</b>
<b>Pulegge sezione SPC per calettatori</b>	<b>pag. 28 -29</b>
<b>Pulegge regolabili per cinghie trapezoidali</b>	<b>pag. 30 -31</b>
<b>Pulegge scanalate POLY-V TAPER-LOCK®</b>	<b>pag. 32 -33</b>
<b>Bussole coniche</b>	<b>pag. 34</b>
<b>Adattatori per bussole coniche</b>	<b>pag. 35</b>
<b>Condizioni generali di Vendita</b>	

## PULEGGE IN GHISA A GOLE TRAPEZOIDALI

Tutte le pulegge a gole trapezoidali sono conformi alla normativa vigente e vengono costruite in ghisa GG 20 con trattamento protettivo di fosfatazione.

Nell'esecuzione normale standard, le pulegge sono tutte bilanciate staticamente e ciò è sufficiente per velocità periferiche fino a 25 m/sec.

Per velocità superiori è indispensabile la bilanciatura dinamica che può venir prevista a richiesta.

**La R.C. Trasmissioni è in grado di eseguire, su richiesta, bilanciature su pulegge Ø max 630, con equilibratrice a CNC, corredando di certificato la bilanciatura eseguita.**

Oltre 35 m/sec, le pulegge in ghisa non sono più idonee e si impone l'uso di materiali ad alta resistenza.

Calcolo della velocità periferica ( $V_p$ )

$$V_p = \frac{\pi \cdot D \cdot n}{60} = \frac{D \cdot n}{19,1} = \text{m/sec.}$$

D = Diametro in metri

n = numero giri al minuto

Le dimensioni riportate sulle tabelle dimensionali non sono impegnative anche se verranno rispettate nei limiti del possibile. Ci riserviamo la facoltà di apportare anche senza preavviso varianti e modifiche.

### Caratteristiche delle gole

Profilo	Dp mm	$\alpha^\circ$	W pg	g	h	b <sub>min</sub>	f	e
SPZ	< 80	34°	8,5	9,7	9	2	8	12
	> 80	38°						
SPA	< 118	34°	11	12,7	11	2,8	10	15
	> 118	38°						
SPB	< 190	34°	14	16,3	14	3,5	12,5	19
	> 190	38°						
SPC	< 315	34°	19	22,0	19	4,8	17	25,5
	> 315	38°						

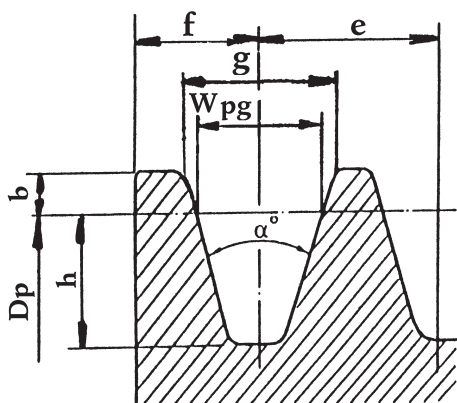

### Larghezza della fascia

N° Gole	SPZ	SPA	SPB	SPC
1	16	20	25	34
2	28	35	44	59,5
3	40	50	63	85
4	52	65	82	111
5	64	80	101	136
6		95	120	162
8			158	213
10			196	264

# PULEGGE A GOLE TRAPEZOIDALI PER BUSSOLA CONICA - FOR TAPER BUSH

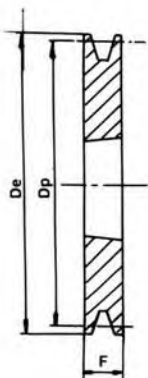

Esec. 1

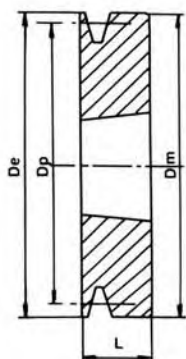

Esec. 2

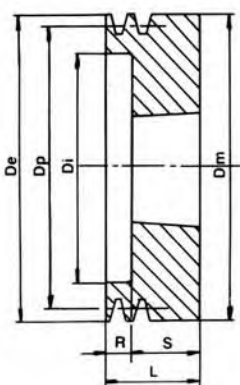

Esec. 3

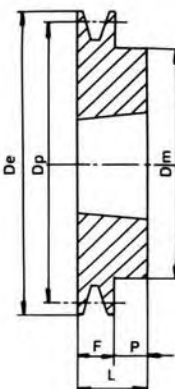

Esec. 4

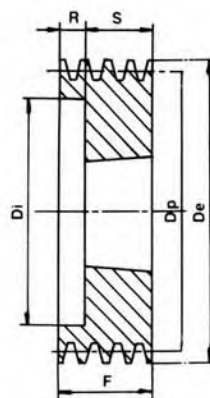

Esec. 5

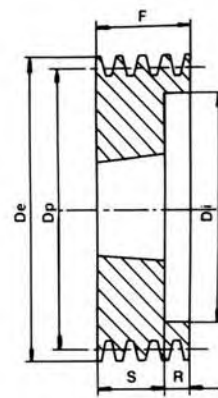

Esec. 6

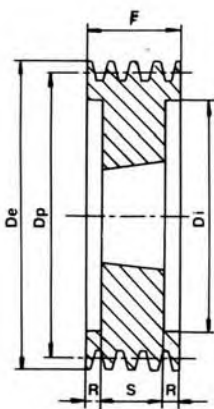

Esec. 7

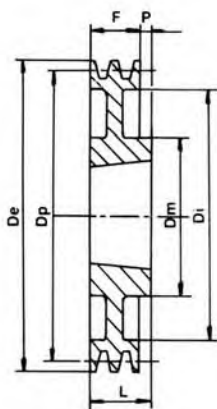

Esec. 8

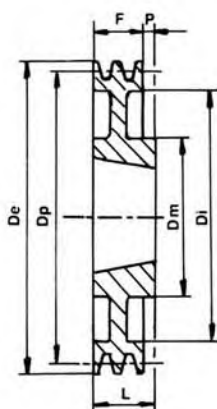

Esec. 8a

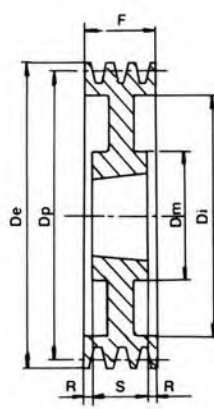

Esec. 9

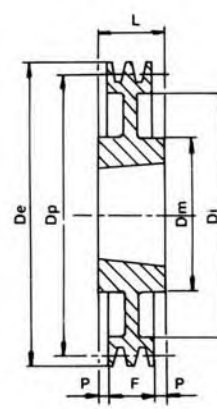

Esec. 10

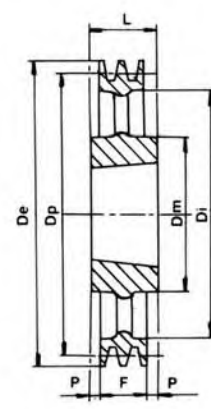

Esec. 11

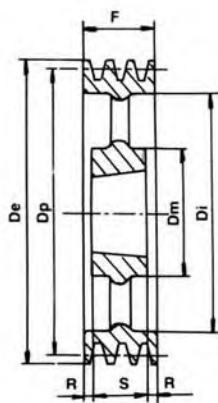

Esec. 12

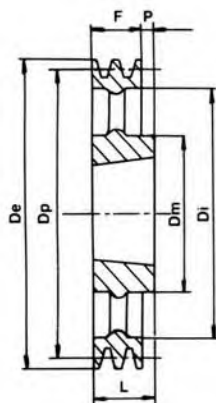

Esec. 13

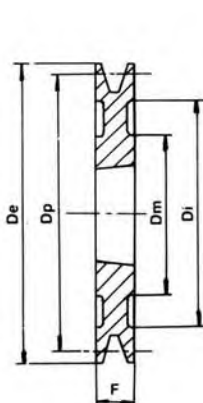

Esec. 14

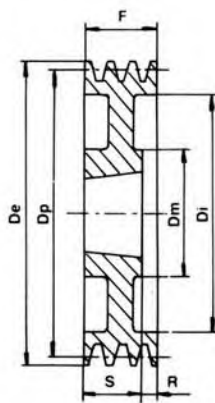

Esec. 15

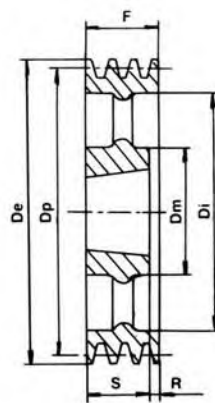

Esec. 16

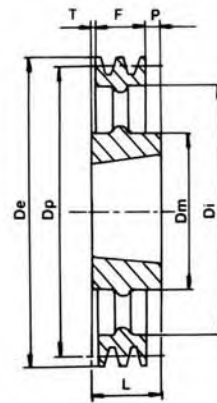

Esec. 17

**PULEGGE A GOLE TRAPEZOIDALI  
PER BUSSOLA CONICA - TAPER BUSH**
**SEZIONE SPZ**

Dp	N° GOLE	ESECUZIONE	BUSSOLA	De	Di	Dm	F	L	P	R	S
60	1	2	1008	64,6		64,6		22			
	2	3	1108	"	36	64,6		49		27	22
63	1	4	1108	67,6		62	16	22	6		
	2	5	1108	"	40		28			6	22
	3	5	1108	"	40		40			18	22
67	1	4	1108	71,6		62	16	22	6		
	2	5	1108	"	42		28			6	22
	3	5	1108	"	42		40			18	22
71	1	4	1108	75,6		62	16	22	6		
	2	5	1108	"	42		28			6	22
	3	5	1108	"	42		40			18	22
75	1	4	1108	79,6		62	16	22	6		
	2	5	1210	"	51		28			3	25
	3	5	1210	"	48		40			15	25
80	1	4	1210	84,6		75	16	25	9		
	2	5	1210	"	51		28			3	25
	3	5	1210	"	51		40			15	25
	4	5	1210	"	51		52			27	25
85	1	4	1210	89,6		75	16	25	9		
	2	5	1610	"	60		28			3	25
	3	5	1610	"	60		40			15	25
	4	5	1610	"	60		52			27	25
	5	5	1610	"	60		64			39	25
90	1	4	1210	94,6		75	16	25	9		
	2	5	1610	"	61		28			3	25
	3	5	1610	"	61		40			15	25
	4	5	1610	"	61		52			27	25
	5	5	1610	"	61		64			39	25
95	1	4	1210	99,6		75	16	25	9		
	2	5	1610	"	66		28			3	25
	3	5	1610	"	66		40			15	25
	4	5	1610	"	66		52			27	25
	5	5	1610	"	66		64			39	25
100	1	4	1210	104,6		75	16	25	9		
	2	5	1610	"	71		28			3	25
	3	5	1610	"	71		40			15	25
	4	5	1610	"	72		52			27	25
	5	5	2012	"	72		64			32	32
106	1	4	1610	110,6		80	16	25	9		
	2	5	1610	"	76		28			3	25
	3	5	1610	"	78		40			15	25
	4	5	1610	"	80		52			27	25
	5	5	2012	"	78		64			32	32

**PULEGGE A GOLE TRAPEZOIDALI  
PER BUSSOLA CONICA - TAPER BUSH**

**SEZIONE SPZ**

Dp	N° GOLE	ESECUZIONE	BUSSOLA	De	Di	Dm	F	L	P	R	S
112	1	4	1610	116,6		80	16	25	9		
	2	5	1610	"	84		28			3	25
	3	5	2012	"	84		40			8	32
	4	5	2012	"	86		52			20	32
	5	5	2012	"	84		64			32	32
118	1	4	1610	122,6		80	16	25	9		
	2	5	1610	"	90		28			3	25
	3	5	2012	"	92		40			8	32
	4	5	2012	"	92		52			20	32
	5	5	2012	"	90		64			32	32
125	1	4	1610	129,6		80	16	25	9		
	2	5	1610	"	97		28			3	25
	3	6	2012	"	97		40			8	32
	4	6	2012	"	99		52			20	32
	5	5	2012	"	97		64			32	32
132	1	4	1610	136,6		80	16	25	9		
	2	5	1610	"	104		28			3	25
	3	6	2012	"	104		40			8	32
	4	6	2012	"	104		52			20	32
	5	5	2517	"	104		64			19	45
140	1	4	1610	144,6		80	16	25	9		
	2	5	1610	"	112		28			3	25
	3	6	2012	"	112		40			8	32
	4	6	2012	"	112		52			20	32
	5	6	2517	"	112		64			19	45
150	1	4	1610	154,6		80	16	25	9		
	2	4	2012	"		100	28	32	4		
	3	6	2012	"	122		40			8	32
	4	6	2517	"	122		52			7	45
	5	6	2517	"	122		64			19	45
160	1	4	1610	164,6		80	16	25	9		
	2	4	2012	"		100	28	32	4		
	3	6	2012	"	132		40			8	32
	4	6	2517	"	132		52			7	45
	5	6	2517	"	132		64			19	45
180	1	4	1610	184,6		80	16	25	9		
	2	8	2012	"	152	100	28	32	4		
	3	6	2012	"	152		40			8	32
	4	6	2517	"	152		52			7	45
	5	6	2517	"	152		64			19	45

**PULEGGE A GOLE TRAPEZOIDALI  
PER BUSSOLA CONICA - TAPER BUSH**

SEZIONE **SPZ**

Dp	N° GOLE	ESECUZIONE	BUSSOLA	De	Di	Dm	F	L	P	R	S
200	1	8	2012	204,6	172	100	16	32	16		
	2	8	2012	"	171	100	28	32	4		
	3	9	2012	"	172	100	40			4	32
	4	9	2517	"	172	120	52			3,5	45
	5	9	2517	"	172	120	64			9,5	45
224	1	8	2012	228,6	196	100	16	32	16		
	2	8	2012	"	196	100	28	32	4		
	3	9	2012	"	196	100	40			4	32
	4	9	2517	"	196	120	52			3,5	45
	5	9	2517	"	196	120	64			9,5	45
250	1	11	2012	254,6	222	100	16	32	8		
	2	11	2012	"	222	100	28	32	2		
	3	12	2012	"	222	100	40			4	32
	4	12	2517	"	222	120	52			3,5	45
	5	12	2517	"	222	120	64			9,5	45
280	1	11	2012	284,6	252	100	16	32	8		
	2	11	2012	"	252	100	28	32	2		
	3	11	2517	"	252	120	40	45	2,5		
	4	12	2517	"	252	120	52			3,5	45
	5	12	2517	"	252	120	64			9,5	45
315	1	11	2012	319,6	287	100	16	32	8		
	2	11	2012	"	287	100	28	32	2		
	3	11	2517	"	287	120	40	45	2,5		
	4	12	2517	"	287	120	52			3,5	45
	5	12	2517	"	287	120	64			9,5	45
355	1	11	2012	359,6	326	100	16	32	8		
	2	11	2012	"	326	100	28	32	2		
	3	11	2517	"	326	120	40	45	2,5		
	4	12	2517	"	326	120	52			3,5	45
	5	12	2517	"	326	120	64			9,5	45
400	1	11	2012	404,6	371	112	16	32	8		
	2	11	2517	"	371	125	28	45			
	3	11	2517	"	371	125	40	45			
	4	12	2517	"	371	125	52	45		3,5	
	5	12	3020	"	371	158	64	51		6,5	
450	1	11	2517	454,6	421	125	16	45	14,5		
	2	11	2517	"	421	125	28	45	8,5		
	3	11	2517	"	421	125	40	45	2,5		
	4	12	3020	"	421	158	52	51		0,5	
	5	12	3020	"	421	158	64	51		8,5	
500	2	11	2517	504,6	471	125	28	45	8,5		
	3	11	2517	"	471	125	40	45	2,5		
	4	12	3020	"	471	158	52	51		0,5	
	5	12	3030	"	471	148	64	76	6		

**PULEGGE A GOLE TRAPEZOIDALI  
PER BUSSOLA CONICA - TAPER BUSH**
**SEZIONE SPA**

Dp	N° GOLE	ESECUZIONE	BUSSOLA	De	Di	Dm	F	L	P	R	S
63	1	3	1008	69,1	37		20	40		18	22
71	1	4	1108	77,1			20				
	2	5	1108	"	40	62	35	22	2	13	22
	3	5	1108	"			50				
75	1	4	1108	81,1		62	20	22	2		
	2	5	1108	"	44		35			13	22
	3	5	1108	"	44		50			28	22
80	1	4	1210	86,1		75	20	25	5		
	2	5	1210	"	47		35			10	25
	3	5	1210	"	47		50			25	25
85	1	4	1210	91,1		75	20	25	5		
	2	5	1210	"	50		35			10	25
	3	5	1210	"	50		50			25	25
90	1	4	1210	96,1		75	20	25	5		
	2	5	1610	"	60		35			10	25
	3	5	1610	"	60		50			25	25
95	1	4	1210	101,1		75	20	25	5		
	2	5	1610	"	64		35			10	25
	3	5	1610	"	64		50			25	25
	4	7	1615	"	64		65			13,5	38
100	1	4	1610	106,1		80	20	25	5		
	2	5	1610	"	70		35			10	25
	3	6	1610	"	70		50			25	25
	4	6	1615	"	70		65			27	38
	5	6	1615	"	70		80			42	38
106	1	4	1610	112,1		80	20	25	5		
	2	5	1610	"	76		35			10	25
	3	6	1610	"	76		50			25	25
	4	5	2012	"	76		65			33	32
	5	5	2012	"	76		80			48	32
112	1	4	1610	118,1		80	20	25	5		
	2	5	1610	"	80		35			10	25
	3	5	2012	"	80		50			18	32
	4	5	2012	"	80		65			33	32
	5	5	2012	"	80		80			48	32
118	1	4	1610	124,1		80	20	25	5		
	2	5	1610	"	86		35			10	25
	3	6	2012	"	86		50			18	32
	4	6	2012	"	86		65			33	32
	5	6	2012	"	86		80			48	32
125	1	4	1610	131,1		80	20	25	5		
	2	5	1610	"	90		35			10	25
	3	6	2012	"	92		50			18	32
	4	6	2012	"	92		65			33	32
	5	7	2012	"	92		80			24	32



**PULEGGE A GOLE TRAPEZOIDALI  
PER BUSSOLA CONICA - TAPER BUSH**
**SEZIONE SPA**

Dp	N° GOLE	ESECUZIONE	BUSSOLA	De	Di	Dm	F	L	P	R	S
132	1	4	1610	138,1		80	20	25	5		
	2	5	2012	"	98		35			3	32
	3	6	2012	"	98		50			18	32
	4	6	2517	"	98		65			20	45
	5	7	2517	"	98		80			17,5	45
140	1	4	1610	146,1		80	20	25	5		
	2	5	2012	"	106		35			3	32
	3	5	2517	"	106		50			5	45
	4	6	2517	"	106		65			20	45
	5	7	2517	"	106		80			17,5	45
150	1	4	1610	156,1		80	20	25	5		
	2	5	2012	"	116		35			3	32
	3	5	2517	"	116		50			5	45
	4	6	2517	"	116		65			20	45
	5	7	2517	"	116		80			17,5	45
160	1	4	1610	166,1		80	20	25	5		
	2	5	2012	"	125		35			3	32
	3	5	2517	"	126		50			5	45
	4	6	2517	"	126		65			20	45
	5	7	2517	"	126		80			17,5	45
170	1	4	1610	176,1		80	20	25	5		
	2	5	2012	"	135		35			3	32
	3	5	2517	"	138		50			5	45
	4	6	2517	"	138		65			20	45
	5	7	3020	"	138		80			14,5	51
180	1	4	1610	186,1		80	20	25	5		
	2	9	2012	"	148	100	35			1,5	32
	3	5	2517	"	146		50			5	45
	4	6	2517	"	146		65			20	45
	5	7	3020	"	146		80			14,5	51
190	1	4	1610	196,1		80	20	25	5		
	2	9	2012	"	158	100	35			1,5	32
	3	5	2517	"	158		50			5	45
	4	6	2517	"	158		65			20	45
	5	7	3020	"	158		80			14,5	51
200	1	8	2012	206,1	165	100	20	32	12		
	2	10	2517	"	165	120	35	45	5		
	3	9	2517	"	165	120	50			2,5	45
	4	6	3020	"	165		65			14	51
	5	7	3020	"	165		80			14,5	51
212	1	8	2012	218,1	177	100	20	32	12		
	2	10	2517	"	177	120	35	45	5		
	3	9	2517	"	177	120	50			2,5	45
	4	6	3020	"	177		65			14	51
	5	7	3020	"	177		80			14,5	51
224	1	8	2012	230,1	189	100	20	32	12		
	2	8	2517	"	189	120	35	45	10		
	3	9	2517	"	189	120	50			2,5	45
	4	6	3020	"	189		65			14	51
	5	6	3020	"	189		80			29	51
236	1	8	2012	242,1	202	106	20	32	12		
	2	8	2517	"	202	125	35	45	10		
	3	9	2517	"	202	125	50			2,5	45
	4	9	3020	"	202	146	65			7	51
	5	9	3020	"	202	155	80			14,5	51

**PULEGGE A GOLE TRAPEZOIDALI  
PER BUSSOLA CONICA - TAPER BUSH**
**SEZIONE SPA**

Dp	N° GOLE	ESECUZIONE	BUSSOLA	De	Di	Dm	F	L	P	R	S
250	1	10	2012	256,1	215	100	20	32	6		
	2	10	2517	"	215	120	35	45	5		
	3	9	2517	"	215	120	50			2,5	45
	4	9	3020	"	215	150	65			7	51
	5	9	3020	"	215	150	80			14,5	51
280	1	8	2012	286,1	245	100	20	32	12		
	2	8	2517	"	245	120	35	45	10		
	3	9	2517	"	245	120	50			2,5	45
	4	9	3020	"	245	150	65			7	51
	5	10	3535	"	245	170	80	89	4,5		
315	1	13	2012	321,1	280	100	20	32	12		
	2	13	2517	"	280	120	35	45	10		
	3	10	3020	"	280	150	50	51	0,5		
	4	9	3020	"	280	150	65			7	51
	5	10	3535	"	280	170	80	89	4,5		
355	1	13	2012	361,1	320	100	20	32	12		
	2	13	2517	"	320	120	35	45	10		
	3	11	3020	"	320	150	50	51	0,5		
	4	12	3020	"	320	150	65			7	51
	5	11	3535	"	320	170	80	89	4,5		
400	1	13	2012	406,1	365	100	20	32	12		
	2	13	2517	"	365	120	35	45	10		
	3	11	3020	"	365	150	50	51	0,5		
	4	12	3020	"	365	150	65			7	51
	5	11	3535	"	365	170	80	89	4,5		
450	1	13	2012	456,1	415	100	20	32	12		
	2	13	2517	"	415	120	35	45	10		
	3	11	3020	"	415	150	50	51	0,5		
	4	12	3020	"	415	150	65			7	51
	5	11	3535	"	415	170	80	89	4,5		
500	1	13	2517	506,1	465	120	20	45	25		
	2	13	2517	"	465	120	35	45	10		
	3	11	3020	"	465	150	50	51	0,5		
	4	12	3020	"	465	150	65			7	51
	5	11	3535	"	465	170	80	89	4,5		
630	2	13	3020	636,1	595	150	35	51	16		
	3	11	3020	"	595	150	50	51	0,5		
	4	11	3535	"	595	170	65	89	12		
	5	11	3535	"	595	170	80	89	4,5		
	6	11	4040	"	595	200	95	102	3,5		
	800	3	11	3535	806,1	765	170	50	89	19,5	
	4	11	3535	"	765	170	65	89	12		
	5	11	4040	"	765	200	80	102	11		

**PULEGGE A GOLE TRAPEZOIDALI  
PER BUSSOLA CONICA - TAPER BUSH**
**SEZIONE SPB**

Dp	N° GOLE	ESECUZIONE	BUSSOLA	De	Di	Dm	F	L	P	R	S
100	1	1	1610	107,6			25				
	2	6	1610	"	57		44			19	25
106	1	1	1610	113,6			25				
	2	6	1610	"	67		44			19	25
	3	6	1610	"	67		63			38	25
112	1	1	1610	119,6			25				
	2	6	1610	"	72		44			19	25
	3	6	1610	"	72		63			38	25
118	1	1	1610	125,6			25				
	2	6	1610	"	78		44			19	25
	3	6	1610	"	78		63			38	25
125	1	1	1610	132,6			25				
	2	6	2012	"	82		44			12	32
	3	6	2012	"	82		63			31	32
	4	7	2012	"	82		82			25	32
	5	5/6	2012	"	82		101			69	32
132	1	1	1610	139,6			25				
	2	6	2012	"	89		44			12	32
	3	6	2012	"	89		63			31	32
	4	7	2012	"	89		82			25	32
	5	5	2517	"	89		101			56	45
140	1	1	1610	147,6			25				
	2	6	2012	"	97		44			12	32
	3	6	2012	"	97		63			31	32
	4	7	2517	"	97		82			18,5	45
	5	7	2517	"	97		101			28	45
	6	7	2517	"	97		120			37,5	45
	7	7	2517	"	97		158			56,5	45
	8	7	2517	"	97		158			56,5	45
150	1	1	1610	157,6			25				
	2	6	2012	"	107		44			12	32
	3	6	2517	"	107		63			18	45
	4	7	2517	"	107		82			18,5	45
	5	7	2517	"	107		101			28	45
	6	7	2517	"	107		120			37,5	45
160	1	1	1610	167,6			25				
	2	6	2012	"	117		44			12	32
	3	6	2517	"	117		63			18	45
	4	7	2517	"	117		82			18,5	45
	5	7	2517	"	117		101			28	45
	6	7	3020	"	117		120			34,5	51
	7	7	3020	"	117		158			53,5	51
	8	7	3020	"	117		158			53,5	51
170	1	1	1610	177,6			25				
	2	6	2012	"	127		44			12	32
	3	6	2517	"	127		63			18	45
	4	7	2517	"	127		82			18,5	45
	5	7	3020	"	127		101			25	51
	6	7	3020	"	127		120			34,5	51
180	1	14	1610	187,6	137	80	25				
	2	4	2517	"		120	44	45	1		
	3	6	2517	"	137		63			18	45
	4	7	2517	"	137		82			18,5	45
	5	7	3020	"	137		101			25	51
	6	7	3020	"	137		120			34,5	51
	7	7	3020	"	137		158			41	76
	8	7	3030	"	137		158			41	76

**PULEGGE A GOLE TRAPEZOIDALI  
PER BUSSOLA CONICA - TAPER BUSH**
**SEZIONE SPB**

Dp	N° GOLE	ESECUZIONE	BUSSOLA	De	Di	Dm	F	L	P	R	S
190	1	10	2012	197,6	147	100	25	32	3,5		
	2	4	2517	"		120	44	45	1		
	3	6	2517	"	147		63			18	45
	4	7	2517	"	147		82			18,5	45
	5	7	3020	"	147		101			25	51
	6	7	3020	"	147		120			34,5	51
	7	7	3030	"	147		158			41	76
	8	7	3030	"	147		158			41	76
200	1	10	2012	207,6	157	100	25	32	3,5		
	2	4	2517	"		120	44	45	1		
	3	6	2517	"	157		63			18	45
	4	6/7	3020	"	157		82			15,5	51
	5	7	3020	"	157		101			25	51
	6	7	3020	"	157		120			34,5	51
	7	7	3535	"	161		158			34,5	89
	8	7	3535	"	161		158			34,5	89
212	1	10	2012	219,6	169	100	25	32	3,5		
	2	8	2517	"	169	120	44	45	1		
	3	15	2517	"	169	120	63			18	45
	4	7	3020	"	169		82			15,5	51
	5	7	3020	"	169		101			25	51
	6	7	3535	"	169		120			15,5	89
	7	7	3535	"	173		158			34,5	89
	8	7	3535	"	173		158			34,5	89
224	1	10	2012	231,6	181	100	25	32	3,5		
	2	8a	2517	"	181	120	44	45	1		
	3	15	2517	"	181	120	63			18	45
	4	6/7	3020	"	181		82			15,5	51
	5	7	3020	"	181		101			25	51
	6	7	3535	"	181		120			15,5	89
	7	7	3535	"	185		158			34,5	89
	8	7	3535	"	185		158			34,5	89
236	1	10	2012	243,6	193	100	25	32	3,5		
	2	8a	2517	"	193	120	44	45	1		
	3	15	2517	"	193	120	63			18	45
	4	7	3020	"	193		82			15,5	51
	5	7	3535	"	193		101			6	89
	6	7	3535	"	193		120			15,5	89
	7	7	3535	"	197		158			34,5	89
	8	7	3535	"	197		158			34,5	89
250	1	10	2012	257,6	207	100	25	32	3,5		
	2	8a	2517	"	207	120	44	45	1		
	3	15	3020	"	207	150	63			12	51
	4	9	3020	"	207	150	82			15,5	51
	5	7	3535	"	207		101			6	89
	6	7	3535	"	207		120			15,5	89
	7	7	3535	"	207		158			34,5	89
	8	7	3535	"	207		158			34,5	89
280	1	10	2012	287,6	237	100	25	32	3,5		
	2	8a	2517	"	237	120	44	45	1		
	3	9	3020	"	237	150	63			6	51
	4	9	3020	"	237	150	82			15,5	51
	5	9	3535	"	237	170	101			6	89
	6	9	3535	"	237	170	120			15,5	89
	7	9	3535	"	237	175	158			34,5	89
	8	9	3535	"	237	175	158			34,5	89
300	1	10	2012	307,6	257	100	25	32	3,5		
	2	8a	2517	"	257	120	44	45	1		
	3	9	3020	"	257	150	63			6	51
	4	9	3020	"	257	150	82			15,5	51
	5	9	3535	"	257	170	101			6	89
	6	9	3535	"	257	170	120			15,5	89
	7	9	3535	"	257	170	158			34,5	89
	8	9	3535	"	257	170	158			34,5	89

**PULEGGE A GOLE TRAPEZOIDALI  
PER BUSSOLA CONICA - TAPER BUSH**
**SEZIONE SPB**

Dp	N° GOLE	ESECUZIONE	BUSSOLA	De	Di	Dm	F	L	P	R	S	T
315	1	10	2012	322,6	272	100	25	32	3,5			
	2	8a	2517	"	272	120	44	45	1			
	3	9	3020	"	272	150	63			6	51	
	4	10	3535	"	272	170	82	89	3,5			
	5	9	3535	"	272	170	101			6	89	
	6	9	3535	"	272	170	120			15,5	89	
	7	9	3535	"	272	170	158			34,5	89	
	8	9	3535	"	272	175	158					
335	2	8a	2517	342,6	292	120	44	45	1			
	3	9	3020	"	292	150	63			6	51	
	4	10	3535	"	292	170	82	89	3,5			
	5	9	3535	"	292	170	101			6	89	
	6	9	3535	"	292	170	120			15,5	89	
	7	9	3535	"	292	170	158			34,5	89	
	8	9	3535	"	292	175	158					
	9	9	3535	"	292	175	158					
355	2	11	3020	362,6	312	150	44	51	3,5			
	3	12	3020	"	312	150	63			6	51	
	4	10	3535	"	312	170	82	89	3,5			
	5	12	3535	"	312	170	101			6	89	
	6	9	3535	"	312	170	120			15,5	89	
	7	9	3535	"	312	170	158			34,5	89	
	8	9	3535	"	312	170	158					
	9	9	3535	"	312	170	158					
400	2	11	3020	407,6	357	150	44	51	3,5			
	3	11	3535	"	357	170	63	89	13			
	4	11	3535	"	357	170	82	89	3,5			
	5	12	3535	"	357	170	101			6	89	
	6	12	3535	"	357	170	120			15,5	89	
	7	12	4040	"	357	200	158			28	102	
	8	12	4040	"	357	200	158					
	9	12	4040	"	357	200	158					
450	2	11	3020	457,6	407	150	44	51	3,5			
	3	13	3535	"	407	170	63	89	26			
	4	13	3535	"	407	170	82	89	7			
	5	16	3535	"	407	170	101			12	89	
	6	16	4040	"	407	200	120			18	102	
	7	16	4040	"	407	200	158			28	102	
	8	12	4040	"	407	200	158					
	9	12	4040	"	407	200	158					
500	2	11	3020	507,6	457	150	44	51	3,5			
	3	13	3535	"	457	170	63	89	26			
	4	13	3535	"	457	170	82	89	7			
	5	16	3535	"	457	170	101			12	89	
	6	16	4040	"	457	200	120			18	102	
	7	16	4040	"	457	200	158			28	102	
	8	12	4040	"	457	200	158					
	9	12	4040	"	457	200	158					
560	2	17	3030	567,6	517	150	44	76	28			
	3	13	3535	"	517	170	63	89	26			
	4	13	3535	"	517	170	82	89	7			
	5	13	4040	"	517	200	101	102	1			4
	6	16	4040	"	517	200	120			18	102	
	7	16	4040	"	517	200	158			22	114	
	8	12	4545	"	517	225	158					
	9	12	4545	"	517	225	158					
630	3	13	3535	637,6	587	170	63	89	26			
	4	13	3535	"	587	170	82	89	7			
	5	13	4040	"	587	200	101	102	1			
	6	16	4040	"	587	200	120			18	102	
	7	16	4040	"	587	200	158			22	114	
	8	12	4545	"	587	225	158					
	9	12	4545	"	587	225	158					
	10	12	4545	"	587	225	158					
710	3	17	3535	717,6	664	170	63	89	22			
	4	11	3535	"	664	170	82	89	3,5			
	5	11	4040	"	664	200	101	102	0,5			4
	6	12	4545	"	664	225	120			3	114	
	7	12	4545	"	664	225	158			22	114	
	8	12	4545	"	664	225	196			41	114	
	9	12	4545	"	664	225	196					
	10	12	4545	"	664	225	196					
800	3	17	3535	807,6	754	170	63	89	22			4
	4	17	4040	"	754	200	82	102	16			4
	5	11	4040	"	754	200	101	102	0,5			
	6	12	4545	"	754	225	120			3	114	
	7	12	4545	"	754	225	158			22	114	
	8	12	4545	"	754	225	196			41	114	
	9	12	4545	"	754	225	196					
	10	12	4545	"	754	225	196					
1000	3	17	4040	1007,6	954	200	63	102	33			6
	4	17	4040	"	954	200	82	102	16			4
	5	11	4545	"	954	225	101	114	6,5			
	6	12	4545	"	954	225	120			3	114	
	7	12	5050	"	954	245	158			15,5	127	
	8	12	5050	"	954	245	196			34,5	127	
1250	4	11	4545	1257,6	1204	225	82	114	16			
	5	11	4545	"	"	225	101	114	16			
	6	11	5050	"	"	245	120	127	3,5			
	7	12	5050	"	"	245	158			15,5	127	
	8	12	5050	"	"	245	158			34,5	127	
	9	12	5050	"	"	245	196					

**PULEGGE A GOLE TRAPEZOIDALI  
PER BUSSOLA CONICA - TAPER BUSH**
**SEZIONE SPC**

Dp	N° GOLE	ESECUZIONE	BUSSOLA	De	Di	Dm	F	L	P	R	S	T
200	2	6	2517	210,2	144		65			20	45	
	3	7	2517	"	144		85			20	45	
	4	7	3020	"	144		111			30	51	
	5	7	3535	"	144		136			23,5	89	
	6	7	3535	"	144		162			36,5	89	
	8	7	3535	"	144		213			62	89	
224	2	6	3020	234,2	173		68			17	51	
	3	7	3020	"	173		85			17	51	
	4	7	3535	"	173		111			11	89	
	5	7	3535	"	173		136			23,5	89	
	6	7	3535	"	173		162			36,5	89	
	8	7	3535	"	170		213			62	89	
250	2	6	3020	260,2	198		68			17	51	
	3	7	3020	"	198		85			17	51	
	4	7	3535	"	198		111			11	89	
	5	7	3535	"	198		136			23,5	89	
	6	7	3535	"	198		162			36,5	89	
	8	7	3535	"	198		213			62	89	
280	2	4	3535	290,2		170	59,5	89	29,5			
	3	4	3535	"		170	85	89	4			
	4	7	3535	"	228		111			11	89	
	5	7	3535	"	228		136			23,5	89	
	6	7	3535	"	228		162			36,5	89	
	8	7	3535	"	228		213			62	89	
10	7	4040	"	222		264			81	102		
300	3	10	3535	310,2	247	170	85	89	2			
	4	9	3535	"	247	170	111			11	89	
	5	9	3535	"	247	170	136			23,5	89	
	6	9	3535	"	247	170	162			36,5	89	
	8	7	4040	"	247		213			55,5	102	
	10	7	4545	"	242		264			75	114	
315	2	8	3535	325,2	264	170	59,5	89	27,5			
	3	10	3535	"	264	170	85	89	2			
	4	9	3535	"	264	170	111			11	89	
	5	9	3535	"	264	170	136			23,5	89	
	6	9	3535	"	264	170	162			36,5	89	
	8	7	4040	"	258	170	213			55,5	102	
10	7	4545	"	258		264			75	114		
335	2	8	3535	345,2	279	170	59,5	89	29,5			
	3	10	3535	"	279	170	85	89	2			
	4	9	3535	"	279	170	111			11	89	
	5	9	3535	"	279	170	136			23,5	89	
	6	9	3535	"	279	170	162			36,5	89	
	8	9	4040	"	279	200	213			55,5	102	
10	7	4545	"	279		264			75	114		
355	2	8	3535	365,2	304	170	59,5	89	27,5			
	3	10	3535	"	304	170	85	89	2			
	4	9	3535	"	304	170	111			11	89	
	5	9	3535	"	304	170	136			23,5	89	
	6	9	3535	"	304	170	162			36,5	89	
	8	7	4040	"	304		213			55,5	102	
10	7	4545	"	299		264			75	114		
400	2	17	3535	410,2	344	170	59,5	89	27,5			2
	3	11	3535	"	344	170	85	89	2		89	
	4	12	3535	"	344	170	111			11	89	
	5	12	3535	"	344	170	136			23,5	102	
	6	9	4040	"	348	200	162			30	114	
	8	12	4545	"	348	225	213			49,5	117	
10	7	5050	"	342		264			68,5	127		

**PULEGGE A GOLE TRAPEZOIDALI  
PER BUSSOLA CONICA - TAPER BUSH**
**SEZIONE SPC**

Dp	N° GOLE	ESECUZIONE	BUSSOLA	De	Di	Dm	F	L	P	R	S	T
450	2	17	3535	460,2	394	170	59,5	89	27,5 2	11 17 24 43 68,5	89 102 114 127	2
	3	11	3535	"	394	170	85	89				
	4	12	3535	"	394	170	111					
	5	12	4040	"	394	200	136					
	6	9	4545	"	394	225	162					
	8	9	5050	"	394	245	213					
	10	9	5050	"	394	245	264					
475	2	17	3535	485,2	419	170	59,5	89	27,5 2	11 17 24 43 68,5	89 102 114 127	2
	3	11	3535	"	419	170	85	89				
	4	12	3535	"	419	170	111					
	5	12	4040	"	419	200	136					
	6	12	4545	"	419	225	162					
	8	12	5050	"	419	245	213					
	10	9	5050	"	419	245	264					
500	2	17	3535	510,2	444	170	59,5	89	27,5 2	11 17 24 43 68,5	89 102 114 127	2
	3	11	3535	"	444	170	85	89				
	4	12	3535	"	444	170	111					
	5	12	4040	"	444	200	136					
	6	12	4545	"	444	225	162					
	8	9	5050	"	444	245	213					
	10	9	5050	"	444	245	264					
560	2	17	3535	570,2	504	170	59,5	89	27,5 2	4,5 11 17,5 43 68,5	102 114 127 127	2
	3	11	3535	"	504	170	85	89				
	4	12	4040	"	504	200	111					
	5	12	4545	"	504	225	136					
	6	12	5050	"	504	245	162					
	8	12	5050	"	504	245	213					
	10	9	5050	"	504	245	264					
630	2	17	4040	640,2	574	200	59,5	102	34 8,5 1,5	4,5 17,5 43 68,5	127 127 127	8,5
	3	11	4040	"	574	200	85	102				
	4	11	4545	"	574	225	111	114				
	5	12	5050	"	574	245	136					
	6	12	5050	"	574	245	162					
	8	12	5050	"	574	245	213					
	10	9	5050	"	574	245	264					
710	4	17	5050	720,2	654	267	111	127	12	4,5 17,5 43 68,5	127 127 127	4
	5	12	5050	"	654	245	136					
	6	12	5050	"	654	245	162					
	8	12	5050	"	654	245	213					
	10	12	5050	"	654	245	264					
800	4	17	5050	810,2	737	245	111	127	12	4,5 17,5 43 68,5	127 127 127	4
	5	12	5050	"	737	245	136					
	6	12	5050	"	737	245	162					
	8	12	5050	"	737	245	213					
	10	12	5050	"	737	245	264					
1000	4	17	5050	1010,2	937	245	111	127	12	4,5 17,5 43 68,5	127 127 127	4
	5	12	5050	"	937	245	136					
	6	12	5050	"	937	245	162					
	8	12	5050	"	937	245	213					
	10	12	5050	"	937	245	264					
1250	5	12	5050	1260,2	1187	245	136			4,5 17,5 43 68,5	127 127 127	
	6	12	5050	"	1187	245	162					
	8	12	5050	"	1187	245	213					
	10	12	5050	"	1187	245	264					

Le dimensioni riportate sulle tabelle dimensionali delle pulegge per bussola conica SPZ-SPA-SPB-SPC non sono impegnative anche se verranno rispettate nei limiti del possibile. Ci riserviamo la facoltà di apportare anche senza preavviso varianti e modifiche

**PULEGGE A GOLE TRAPEZOIDALI  
MOZZO PIENO - PLAIN HUB**

SEZIONE **SPA**

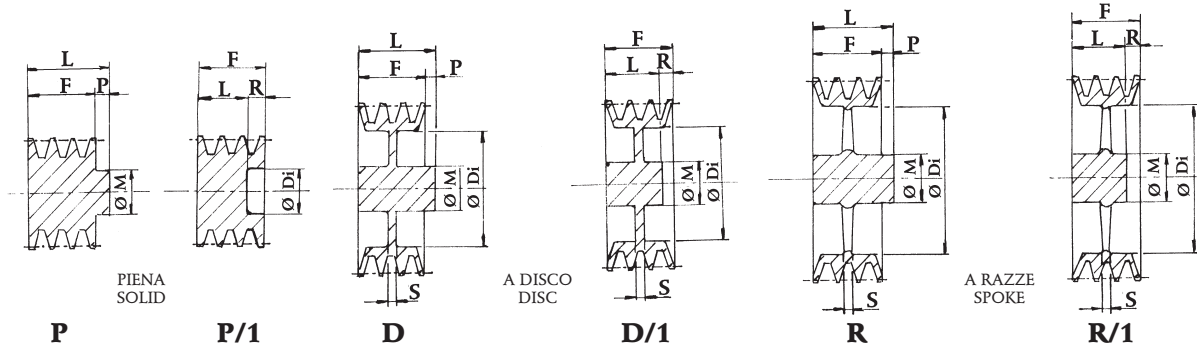

**FORME COSTRUTTIVE - CONSTRUCTION SHAPES**

Dp	N° GOLE	FORMA	Ø M	L	Ø Di	S <sub>min</sub>	F	P	R
40	1	P	40	35			20	15	
50	1	P	40	35			20	15	
	2	P	40	45			35	10	
60	1	P	40	35			20	15	
	2	P	40	45			35	10	
	3	P	40	50			50		
65	1	P	40	40			20	20	
	2	P	50	45			35	10	
	3	P	52	50			50		
70	1	P	40	40			20	20	
	2	P	50	45			35	10	
	3	P	52	50			50		
	4	P		65			65		
75	1	P	40	40			20	20	
	2	P	50	45			35	10	
	3	P	52	50			50		
	4	P	52	65			65		
	5	P	52	80			80		
80	1	P	45	40			20	20	
	2	P	50	45			35	10	
	3	P	62	50			50		
	4	P	62	65			65		
	5	P	62	80			80		
85	1	P	45	40			20	20	
	2	P	50	45			35	10	
	3	P	62	50			50		
	4	P	62	65			65		
	5	P	62	80			80		
90	1	P	45	40			20	20	
	2	P	60	45			35	10	
	3	P	62	50			50		
	4	P	68	65			65		
	5	P	68	80			80		
95	1	P	45	40			20	20	
	2	P	60	45			35	10	
	3	P	62	50			50		
	4	P	68	65			65		
	5	P	68	80			80		

Dp	N° GOLE	FORMA	Ø M	L	Ø Di	S <sub>min</sub>	F	P	R
100	1	P	48	40			20	20	
	2	P	60	45			35	10	
	3	P	62	50			50		
	4	P/1		52	67		65		13
	5	P/1		52	67		80		28
105	1	P	48	40			20	20	
	2	P	60	45			35	10	
112	1	P	48	40			20	20	
	2	P	60	45			35	10	
	3	P	62	50			50		
	4	P/1		52	79		65		13
	5	P/1		52	79		80		28
120	1	P	60	40			20	20	
	2	P	60	50			35	15	
	3	P	70	50			50		
	4	P/1		52	87		65		13
	5	P/1		52	87		80		28
125	1	P	60	40			20	20	
	2	P	60	50			35	15	
	3	P	70	50			50		
130	1	P	60	40			20	20	
	2	P	60	45			35	10	
	3	P	70	52			50		
	4	P/1		52	97		65		13
	5	P/1		52	97		80		28
140	1	D	60	40	107	10	20	20	
	2	D	60	50	107	10	35	15	
	3	D	70	52	107	12	50	2	
	4	P/1		52	107		65		13
	5	P/1		52	107		80		28
150	1	D	60	40	107	10	20	20	
	2	D	60	45	107	10	35	10	
	3	D	70	52	107	12	50	2	
	4	P/1		52	107		65		13
	5	P/1		52	107		80		28



**PULEGGE A GOLE TRAPEZOIDALI  
MOZZO PIENO - PLAIN HUB**

SEZIONE **SPA**

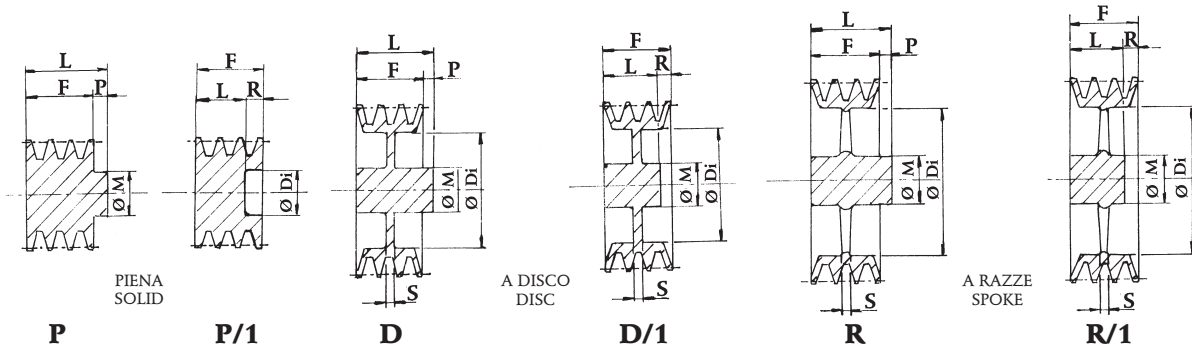

**FORME COSTRUTTIVE - CONSTRUCTION SHAPES**

Dp	N° GOLE	FORMA	ø M	L	ø Di	S <sub>min</sub>	F	P	R
160	1	D	60	40	127	10	20	20	
	2	D	60	50	127	10	35	15	
	3	D	70	52	127	12	50	2	
	4	D/1	70	52	127	18	65		13
	5	D/1	80	52	127	18	80		28
170	1	D	60	40	137	12	20	20	
	2	D	60	45	137	12	35	10	
	3	D	70	52	137	12	50	2	
	4	D/1	80	52	137	18	65		13
	5	D/1	80	52	137	18	80		28
180	1	D	65	40	147	12	20	20	
	2	D	70	50	147	12	35	15	
	3	D	70	52	147	12	50	2	
	4	D/1	80	60	147	18	65		5
	5	D/1	80	65	147	18	80		15
200	1	D	65	45	167	12	20	25	
	2	D	70	50	167	12	35	15	
	3	D	70	50	167	12	50		
	4	D/1	80	60	167	18	65		5
	5	D/1	80	65	167	18	80		15
225	1	D	65	45	192	12	20	25	
	2	D	70	50	192	12	35	15	
	3	D	80	50	192	12	50		
	4	D/1	90	60	192	18	65		5
	5	D/1	90	65	192	18	80		15
250	1	D	75	50	217	12	20	30	
	2	D	75	50	217	12	35	15	
	3	D	80	60	217	12	50	10	
	4	D	90	65	217	18	65		
	5	D/1	90	65	217	18	80		15
280	1	R	75	50	247	14	20	30	
	2	R	80	50	247	14	35	15	
	3	R	80	60	247	14	50	10	
	4	R	90	65	247	14	65		
	5	R/1	100	65	247	14	80		15
300	1	R	75	50	267	14	20	30	
	2	R	80	50	267	14	35	15	
	3	R	80	60	267	14	50	10	
	4	R	90	70	267	14	65	5	
	5	R/1	100	70	267	14	80		10
315	1	R	75	50	282	14	20	30	
	2	R	80	50	282	14	35	15	
	3	R	90	60	282	14	50	10	
	4	R	90	65	282	14	65		
	5	R/1	100	65	282	16	80		15

Dp	N° GOLE	FORMA	ø M	L	ø Di	S <sub>min</sub>	F	P	R
355	1	R	75	50	322	14	20	30	
	2	R	80	50	322	14	35	15	
	3	R	90	60	322	14	50	10	
	4	R	95	65	322	18	65		
	5	R/1	100	65	322	20	80		15
380	1	R	80	50	347	14	20	30	
	2	R	90	50	347	14	35	15	
	3	R	90	60	347	14	50	10	
	4	R	95	65	347	18	65		
	5	R/1	100	65	347	20	80		15
400	1	R	90	50	367	14	20	30	
	2	R	90	50	367	14	35	15	
	3	R	100	60	367	16	50	10	
	4	R	100	65	367	20	65		
	5	R/1	100	65	367	24	80		15
450	1	R	90	50	417	14	20	30	
	2	R	100	50	417	14	35	15	
	3	R	100	60	417	16	50	10	
	4	R/1	105	65	417	20	65		
	5	R/1	105	65	417	24	80		15
500	1	R	90	50	467	14	20	30	
	2	R	100	50	467	16	35	15	
	3	R	105	60	467	20	50	10	
	4	R/1	105	65	467	25	65		
	5	R/1	110	65	467	28	80		15
560	1	R	100	50	527	16	20	30	
	2	R	100	50	527	20	35	15	
	3	R	120	65	527	22	50	15	
	4	R	120	65	527	25	65		
	5	R	120	80	527	30	80		
	6	R/1	120	80	527	32	95		15
600	1	R	100	50	567	16	20	30	
	2	R	110	50	567	20	35	15	
	3	R	120	65	567	22	50	15	
	4	R	120	65	567	25	65		
	5	R	120	80	567	30	80		
	6	R/1	120	80	567	32	95		15
630	1	R	100	50	597	16	20	30	
	2	R	110	50	597	20	35	15	
	3	R	120	65	597	22	50	15	
	4	R	120	65	597	25	65		
	5	R	120	80	597	30	80		
	6	R/1	120	80	597	32	95		15

**PULEGGE A GOLE TRAPEZOIDALI  
MOZZO PIENO - PLAIN HUB**

SEZIONE **SPB**

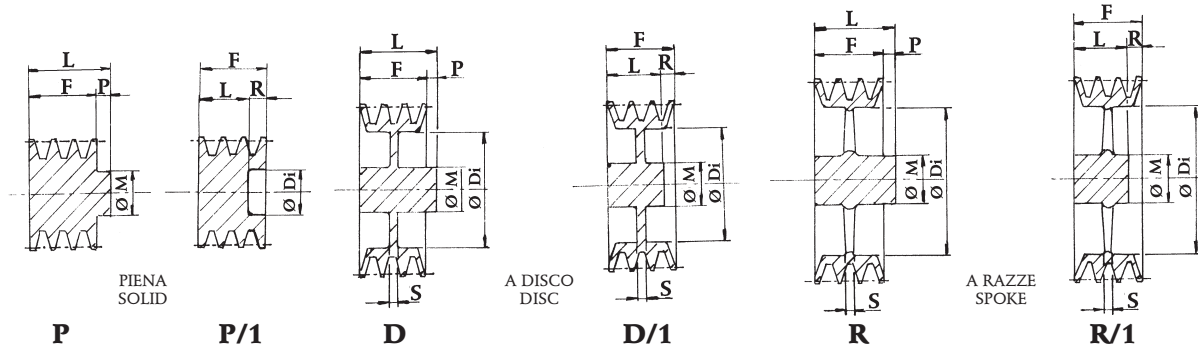

**FORME COSTRUTTIVE - CONSTRUCTION SHAPES**

Dp	N° GOLE	FORMA	Ø M	L	Ø Di	S <sub>min</sub>	F	P	R
60	3	P	50	67			63	4	
70	1	P	45	45			25	20	
	2	P	45	55			44	11	
80	1	P	50	45			25	20	
	2	P	50	55			44	11	
	3	P	50	63			63		
	4	P	50	82			82		
90	1	P	50	45			25	20	
	2	P	50	55			44	11	
	3	P	50	63			63		
	4	P	50	82			82		
	5	P	50	101			101		
100	1	P	52	45			25	20	
	2	P	55	55			44	11	
	3	P	55	63			63		
	4	P	55	82			82		
	5	P	55	101			101		
112	1	P	55	45			25	20	
	2	P	60	55			44	11	
	3	P	60	63			63		
	4	P	60	82			82		
	5	P	60	101			101		
120	1	P	55	45			25	20	
	2	P	60	55			44	11	
	3	P	75	63			63		
	4	P	75	82			82		
	5	P	75	101			101		
	6	P	75	120			120		
125	1	P	58	45			25	20	
	2	P	60	55			44	11	
	3	P/1	60	60	83		63		3
	4	P/1	60	60	83		82		22
	5	P/1	60	60	83		101		41
	6	P/1	60	60	83		120		60

Dp	N° GOLE	FORMA	Ø M	L	Ø Di	S <sub>min</sub>	F	P	R
130	1	P	60	45			25	20	
	2	P	60	55			44	11	
	3	P/1	60	60	88		63		3
	4	P/1	60	60	88		82		22
	5	P/1	60	60	88		101		41
	6	P/1	60	60	88		120		60
140	1	P	65	45			25	20	
	2	P	65	55			44	11	
	3	P/1	65	60	98		63		3
	4	P/1	65	60	98		82		22
	5	P/1	65	60	98		101		41
	6	P/1	65	60	98		120		60
150	1	P	65	45			25	20	
	2	P	65	55			44	11	
	3	P/1	65	60	108		63		3
	4	P/1	65	60	108		82		22
	5	P/1	65	60	108		101		41
	6	P/1	65	60	108		120		60
160	1	D	65	45	118	12	25	20	
	2	D	70	55	118	12	44	11	
	3	P/1	65	60	118		63		3
	4	P/1	65	60	118		82		22
	5	P/1	65	60	118		101		41
	6	P/1	65	65	118		120		55
170	1	D	65	45	128	12	25	20	
	2	D	70	55	128	12	44	11	
	3	P/1	65	60	128		63		3
	4	P/1	65	60	128		82		22
	5	P/1	65	60	128		101		41
	6	P/1	65	65	128		120		55
180	1	D	65	45	138	12	25	20	
	2	D	70	55	138	12	44	11	
	3	D/1	80	60	138	18	63		3
	4	P/1	65	60	138		82		22
	5	P/1	65	70	138		101		31
	6	P/1	65	70	138		120		50

**PULEGGE A GOLE TRAPEZOIDALI  
MOZZO PIENO - PLAIN HUB**

**SEZIONE SPB**

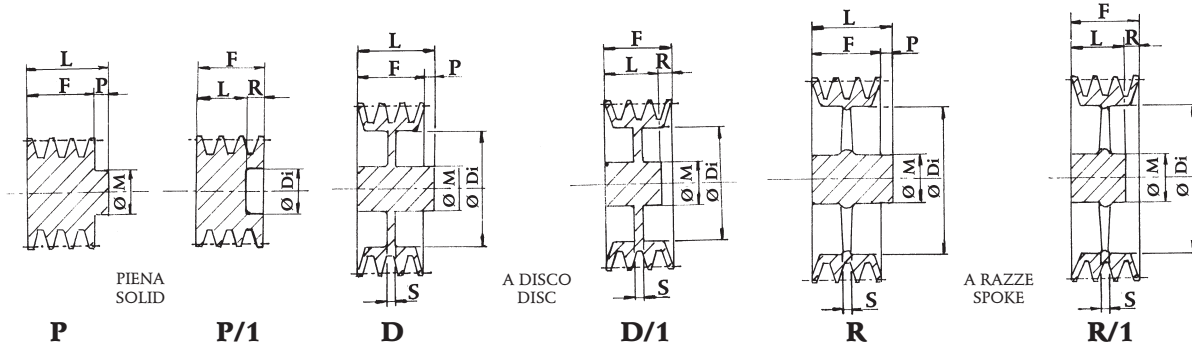

**FORME COSTRUTTIVE - CONSTRUCTION SHAPES**

Dp	N° GOLE	FORMA	Ø M	L	Ø Di	S <sub>min</sub>	F	P	R
200	1	D	70	45	158	14	25	20	
	2	D	70	55	158	14	44	11	
	3	D/1	88	60	158	18	63		3
	4	D/1	88	60	158	25	82		22
	5	D/1	96	70	158	25	101		31
	6	D/1	96	80	158	25	120		50
212	1	D	70	45	170	14	25	20	
	2	D	77	55	170	14	44	11	
	3	D/1	88	60	170	18	63		3
	4	D/1	88	60	170	25	82		22
	5	D/1	96	70	170	25	101		31
	6	D/1	104	80	170	25	120		40
225	1	D	70	45	183	14	25	20	
	2	D	77	55	183	14	44	11	
	3	D/1	88	60	183	18	63		3
	4	D/1	88	60	183	25	82		22
	5	D/1	96	70	183	25	101		31
	6	D/1	104	80	183	25	120		40
250	1	D	70	50	208	14	25	25	
	2	D	77	55	208	14	44	11	
	3	D/1	88	60	208	18	63		3
	4	D/1	96	65	208	25	82		17
	5	D/1	104	75	208	25	101		26
	6	D/1	104	80	208	25	120		40
280	1	R	76	50	238	14	25	25	
	2	R	80	55	238	14	44	11	
	3	R/1	90	60	238	18	63		3
	4	R/1	96	65	238	25	82		17
	5	R/1	104	75	238	25	101		26
	6	R/1	104	80	238	25	120		40
300	1	R	76	50	258	15	25	25	
	2	R	80	55	258	15	44	11	
	3	R/1	90	60	258	18	63		3
	4	R/1	96	65	258	20	82		17
	5	R/1	104	75	258	22	101		26
	6	R/1	104	80	258	22	120		40
315	1	R	76	50	273	15	25	25	
	2	R	88	60	273	15	44	16	
	3	R/1	90	60	273	18	63		3
	4	R/1	96	65	273	20	82		17
	5	R/1	104	75	273	22	101		26
	6	R/1	120	90	273	22	120		30
340	1	R	80	50	298	15	25	25	
	2	R	88	60	298	15	44	16	
	3	R/1	92	60	298	18	63		3
	4	R/1	96	65	298	20	82		17
	5	R/1	104	75	298	22	101		26
	6	R/1	120	90	298	22	120		30
355	1	R	80	50	313	16	25	25	
	2	R	88	60	313	18	44	16	
	3	R/1	92	60	313	22	63		3
	4	R/1	96	65	313	22	82		17
	5	R/1	104	75	313	24	101		26
	6	R/1	120	90	313	24	120		30
380	1	R	85	55	338	20	25	30	
	2	R	88	60	338	20	44	16	
	3	R	96	65	338	22	63	2	
	4	R/1	104	75	338	24	82		7
	5	R/1	112	85	338	24	101		16
	6	R/1	120	100	338	28	120		20
400	1	R	85	55	358	20	25	30	
	2	R	88	60	358	20	44	16	
	3	R	96	65	358	22	63	2	
	4	R/1	104	75	358	24	82		7
	5	R/1	112	85	358	24	101		16
	6	R/1	120	100	358	28	120		20
425	3	R	96	65	383	24	63	2	
	4	R/1	104	75	383	24	82		7
	5	R/1	112	85	383	28	101		16

**PULEGGE A GOLE TRAPEZOIDALI  
MOZZO PIENO - PLAIN HUB**

SEZIONE **SPB**

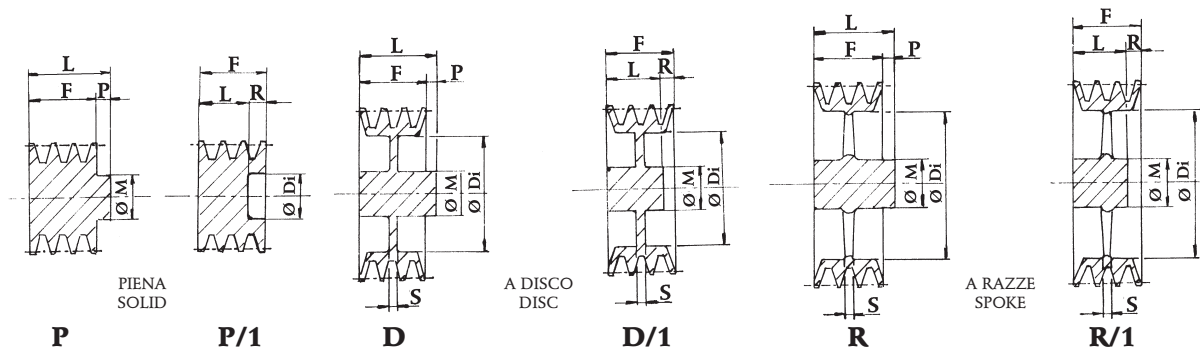

**FORME COSTRUTTIVE - CONSTRUCTION SHAPES**

Dp	N° GOLE	FORMA	Ø M	L	Ø Di	S min	F	P	R
450	1	R	90	60	408	20	25	35	
	2	R	90	60	408	20	44	16	
	3	R	96	65	408	24	63	2	
	4	R/1	104	75	408	26	82		7
	5	R/1	112	85	408	26	101		16
	6	R/1	120	100	408	30	120		20
500	1	R	100	60	458	20	25	35	
	2	R	100	65	458	20	44	21	
	3	R	104	75	458	24	63	12	
	4	R	112	85	458	26	82	3	
	5	R/1	120	90	458	30	101		11
	6	R/1	129	105	458	30	120		15
560	1	R	100	60	518	20	25	35	
	2	R	100	65	518	20	44	21	
	3	R	104	75	518	24	63	12	
	4	R	112	85	518	26	82	3	
	5	R/1	120	90	518	30	101		11
	6	R/1	128	105	518	35	120		15
600	1	R	100	60	558	22	25	35	
	2	R	100	65	558	22	44	21	
	3	R	104	75	558	28	63	12	
	4	R	115	85	558	28	82	3	
	5	R/1	120	90	558	30	101		11
	6	R/1	128	105	558	35	120		15
630	1	R	100	60	588	22	25	35	
	2	R	100	65	588	28	44	21	
	3	R	104	75	588	28	63	12	
	4	R	120	85	588	32	82	3	
	5	R/1	128	90	588	32	101		11
	6	R/1	145	105	588	35	120		15

**PULEGGE A GOLE TRAPEZOIDALI  
MOZZO PIENO - PLAIN HUB**

SEZIONE **SPC**

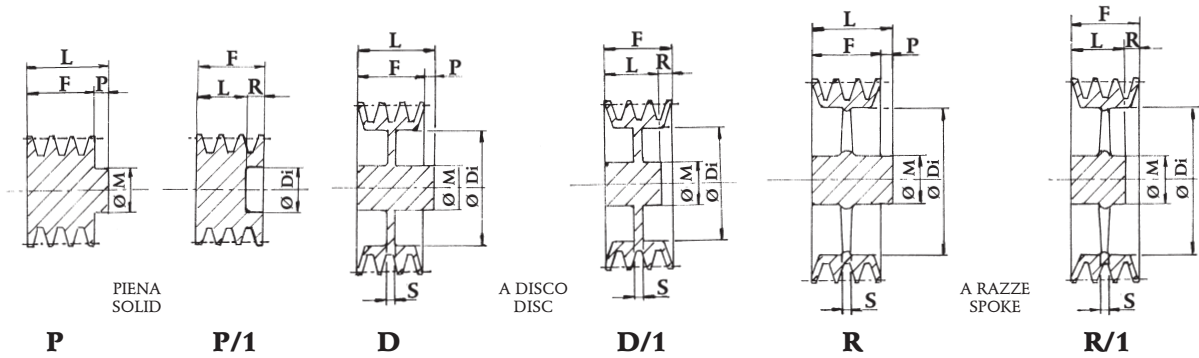

**FORME COSTRUTTIVE - CONSTRUCTION SHAPES**

Dp	N° GOLE	FORMA	Ø M	L	Ø Di	S min	F	P	R
100	1	P	60	50			34	16	
120	1	P	65	50			34	16	
	2	P	65	65			59,5	5,5	
140	1	P	70	55			34	21	
	2	P		59,5			59,5		
	3	P/1	65	83			85		20
	4	P/1	80	83			111		30,5
150	1	P	70	50			34	16	
	2	P	72	59,5			59,5		
	3	P/1	65	93			85		20
	4	P/1	80	93			111		30,5
	5	P/1	96	93			136		40
160	1	P	72	50			34	16	
	2	P		59,5			59,5		
	3	P/1	65	103			85		20
	4	P/1	80	103			111		30,5
	5	P/1	96	103			136		40
	6	P/1	96	103			162		65,5
180	1	D	76	50	123	16	34	16	
	2	D	80	60	123	16	59,5	0,5	
	3	D/1	82	65	123	18	85		20
	4	D/1	82	80	123	20	111		30,5
	5	D/1	82	96	123	20	136		40
	6	D/1	82	96	123	25	162		65,5
200	1	D	76	50	143	16	34	16	
	2	D	80	60	143	16	59,5	0,5	
	3	D/1	86	65	143	18	85		20
	4	D/1	90	90	143	25	111		20,5
	5	D/1	90	100	143	25	136		36
	6	D/1	90	100	143	25	162		61,5
225	1	D	86	50	168	18	34	16	
	2	D	88	60	168	18	59,5	0,5	
	3	D/1	90	70	168	25	85		15
	4	D/1	90	90	168	25	111		20,5
	5	D/1	90	100	168	25	136		36
	6	D/1	90	100	168	25	162		61,5

Dp	N° GOLE	FORMA	Ø M	L	Ø Di	S min	F	P	R
250	1	D	86	50	193	18	34	16	
	2	D	92	60	193	18	59,5	0,5	
	3	D/1	92	70	193	25	85		15
	4	D/1	100	90	193	25	111		20,5
	5	D/1	102	100	193	25	136		36
	6	D/1	102	100	193	25	162		61,5
280	1	D	86	50	223	18	34	16	
	2	D	92	60	223	18	59,5	0,5	
	3	D/1	92	70	223	25	85		15
	4	D/1	100	90	223	25	111		10,5
	5	D/1	102	100	223	25	136		36
	6	D/1	102	100	223	25	162		61,5
300	1	D	86	50	243	20	34	16	
	2	D	92	60	243	20	59,5	0,5	
	3	D/1	92	70	243	25	85		15
	4	D/1	100	90	243	25	111		20,5
	5	D/1	104	100	243	25	136		36
	6	D/1	104	100	243	25	162		61,5
315	1	R	92	50	258	20	34	16	
	2	R	92	60	258	20	59,5	0,5	
	3	R/1	92	70	258	25	85		15
	4	R/1	110	90	258	25	111		20,5
	5	R/1	112	100	258	25	136		36
	6	R/1	112	100	258	30	162		61,5
340	1	R	100	50	283	25	34	16	
	2	R	100	60	283	25	59,5	0,5	
	3	R/1	100	70	283	25	85		15
	4	R/1	114	90	283	30	111		20,5
	5	R/1	114	100	283	30	136		36
	6	R/1	114	100	283	30	162		61,5
355	1	R	110	50	298	25	34	16	
	2	R	110	60	298	25	59,5	0,5	
	3	R/1	110	70	298	25	85		15
	4	R/1	114	90	298	30	111		20,5
	5	R/1	114	100	298	30	136		36
	6	R/1	114	100	298	30	162		61,5

# PULEGGE A GOLE TRAPEZOIDALI MOZZO PIENO - PLAIN HUB

# SEZIONE SPC

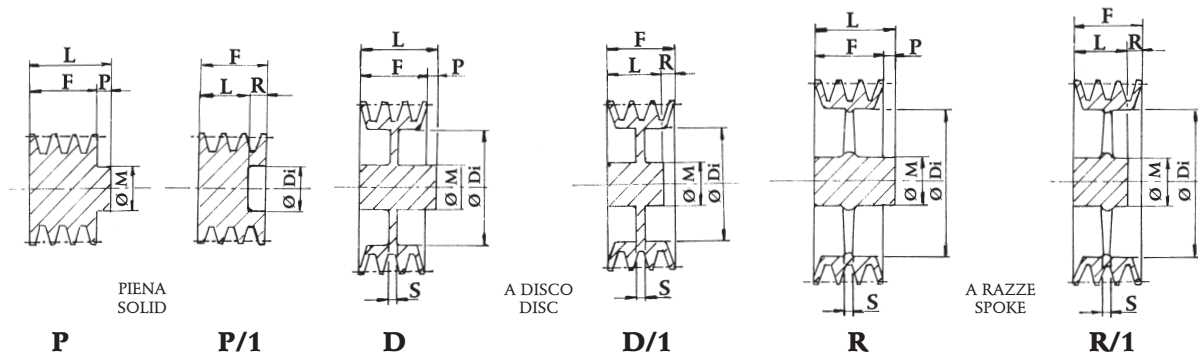

## FORME COSTRUTTIVE - CONSTRUCTION SHAPES

Dp	N° GOLE	FORMA	Ø M	L	Ø Di	S <sub>min</sub>	F	P	R
380	1	R	110	50	323	25	34	16	
	2	R	110	60	323	25	59,5	0,5	
	3	R/1	110	70	323	25	85		15
	4	R/1	114	90	323	30	111		20,5
	5	R/1	114	100	323	30	136		36
	6	R/1	114	100	323	30	162		61,5
400	1	R	110	60	343	25	34	26	
	2	R	110	70	343	25	59,5	10,5	
	3	R	114	90	343	30	85	5	
	4	R/1	120	90	343	30	111		20,5
	5	R/1	120	100	343	35	136		36
	6	R/1	120	100	343	35	162		61,5
450	1	R	110	60	393	25	34	26	
	2	R	110	70	393	25	59,5	10,5	
	3	R	114	90	393	30	85	5	
	4	R/1	120	90	393	30	111		20,5
	5	R/1	120	100	393	35	136		36
	6	R/1	120	100	393	35	162		61,5
500	1	R	114	60	443	25	34	26	
	2	R	114	70	443	25	59,5	10,5	
	3	R	114	90	443	30	85	5	
	4	R/1	126	100	443	30	111		10,5
	5	R/1	126	100	443	35	136		36
	6	R/1	126	100	443	35	162		61,5
560	1	R	114	60	503	30	34	26	
	2	R	114	70	503	30	59,5	10,5	
	3	R	114	90	503	30	85	5	
	4	R/1	130	100	503	32	111		10,5
	5	R/1	130	100	503	35	136		36
	6	R/1	130	100	503	35	162		61,5
600	1	R	114	60	543	30	34	26	
	2	R	114	70	543	30	59,5	10,5	
	3	R	114	90	543	30	85	5	
	4	R/1	130	100	543	32	111		10,5
	5	R/1	130	100	543	35	136		36
	6	R/1	130	100	543	35	162		61,5
630	1	R	114	60	573	30	34	26	
	2	R	114	70	573	30	59,5	10,5	
	3	R	114	90	573	30	85	5	
	4	R/1	130	100	573	32	111		10,5
	5	R/1	130	100	573	35	136		36
	6	R/1	130	100	573	35	162		61,5

Le dimensioni riportate sulle tabelle dimensionali delle pulegge a gole trapezoidali con mozzo pieno sezioni SPA - SPB - SPC non sono impegnative anche se verranno rispettate nei limiti del possibile. Ci riserviamo la facoltà di apportare anche senza preavviso varianti e modifiche.

**PULEGGE A GOLE TRAPEZOIDALI  
PER CALETTATORI - FOR LOCKING ASSEMBLIES**

SEZIONE **SPA**

Dp	N° GOLE	FORMA	Ø D <sup>H8</sup>			F	L	Ø M	R	Ø Di	S
			Ø 55	Ø 65	Ø 80						
90	1	P	55			20					
	2	P	55			35					
	3	P	55			50					
	4	P	55			65					
	5	P	55			80					
95	1	P	55			20					
	2	P	55			35					
	3	P	55			50					
	4	P	55			65					
	5	P	55			80					
100	1	P	55	65		20					
	2	P	55	65		35					
	3	P	55	65		50					
	4	P	55	65		65					
	5	P	55	65		80					
105	1	P	55	65		20					
	2	P	55	65		35					
	3	P	55	65		50					
	4	P	55	65		65					
	5	P	55	65		80					
112	1	P	55	65		20					
	2	P/1	55	65		35	27	8	79		
	3	P/1	55	65		50	27	23	79		
	4	P/1	55	65		65	27	38	79		
	5	D	55	65		80	27	26,5	79	27	
120	1	P	55	65	80	20					
	2	P/1	55	65	80	35	27	8	88		
	3	P/1	55	65	80	50	27	23	88		
	4	P/1	55	65	80	65	27	38	88		
	5	D	55	65	80	80	27	26,5	88	27	
125	1	P	55	65	80	20					
	2	P/1	55	65	80	35	27	8	92		
	3	P/1	55	65	80	50	27	23	92		
	4	P/1	55	65	80	65	27	38	92		
	5	D	55	65	80	80	27	26,5	92	27	
130	1	P	55	65	80	20					
	2	P/1	55	65	80	35	27	8	97		
	3	P/1	55	65	80	50	27	23	97		
	4	P/1	55	65	80	65	27	38	97		
	5	D	55	65	80	80	27	26,5	97	27	
140	1	P	55	65	80	20					
	2	P/1	55	65	80	35	27	8	107		
	3	P/1	55	65	80	50	27	23	107		
	4	P/1	55	65	80	65	27	38	107		
	5	D	55	65	80	80	27	26,5	107	27	

FORME COSTRUTTIVE  
CONSTRUCTION SHAPES

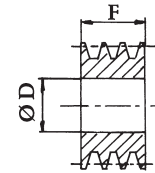

**P**

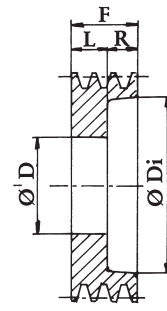

**P/1**

PIENA  
SOLID

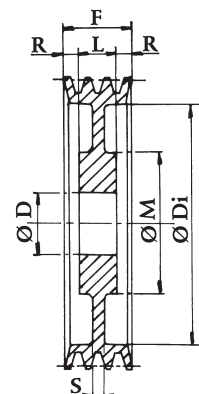

**D**

A DISCO  
DISC

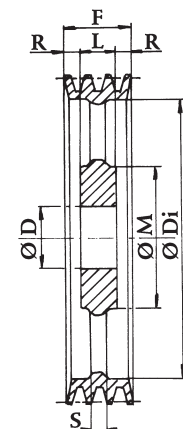

**R**

A RAZZE  
SPOKE

**PULEGGE A GOLE TRAPEZOIDALI  
PER CALETTATORI - FOR LOCKING ASSEMBLIES**

SEZIONE **SPA**

Dp	N° GOLE	FORMA	Ø DH8			F	L	Ø M	R	Ø Di	S
			Ø 55	Ø 65	Ø 80						
150	1	P	55	65	80	20					
	2	P/1	55	65	80	35	27		8	117	
	3	P/1	55	65	80	50	27		23	117	
	4	P/1	55	65	80	65	27		38	117	
	5	D	55	65	80	80	27		26,5	117	27
160	1	P	55	65	80	20					
	2	P/1	55	65	80	35	27		8	127	
	3	P/1	55	65	80	50	27		23	127	
	4	P/1	55	65	80	65	27		38	127	
	5	D	55	65	80	80	27		26,5	127	27
170	1	P	55	65	80	20					
	2	D	55	65	80	35	27		4	137	27
	3	D	55	65	80	50	27		11,5	137	27
	4	D	55	65	80	65	27		19	137	27
	5	D	55	65	80	80	27		26,5	137	27
180	1	P	55	65	80	20					
	2	D	55	65	80	35	27		4	147	27
	3	D	55	65	80	50	27		11,5	147	27
	4	D	55	65	80	65	27		19	147	27
	5	D	55	65	80	80	27		26,5	147	27
190	1	P	55	65	80	20					
	2	D	55	65	80	35	27	120	4	157	12
	3	D	55	65	80	50	27	120	11,5	157	12
	4	D	55	65	80	65	27	120	19	157	12
	5	D	55	65	80	80	27	120	26,5	157	12
200	1	P	55	65	80	20					
	2	D	55	65	80	35	27	120	4	167	12
	3	D	55	65	80	50	27	120	11,5	167	14
	4	D	55	65	80	65	27	120	19	167	14
	5	D	55	65	80	80	27	120	26,5	167	14
225	1	D	55	65	80	20	20	120		192	12
	2	D	55	65	80	35	27	120	4	192	12
	3	D	55	65	80	50	27	120	11,5	192	14
	4	D		65	80	65	27	120	19	192	14
	5	D		65	80	80	27	120	26,5	192	14
250	1	R	55	65	80	20	20	130		217	14
	2	R	55	65	80	35	27	130	4	217	14
	3	R	55	65	80	50	27	130	11,5	217	14
	4	R		65	80	65	27	130	19	217	14
	5	R		65	80	80	27	130	26,5	217	14
280	1	R	55	65	80	20	20	130		247	14
	2	R	55	65	80	35	27	130	4	247	14
	3	R	55	65	80	50	27	130	11,5	247	14
	4	R		65	80	65	27	130	19	247	14
	5	R		65	80	80	27	130	26,5	247	14

FORME COSTRUTTIVE  
CONSTRUCTION SHAPES

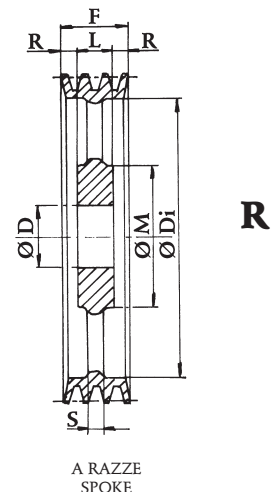
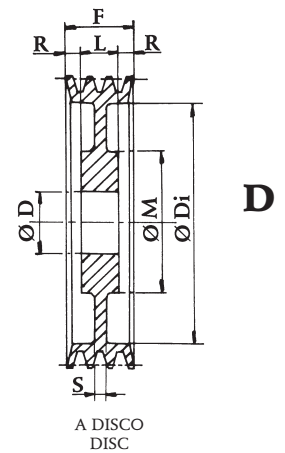
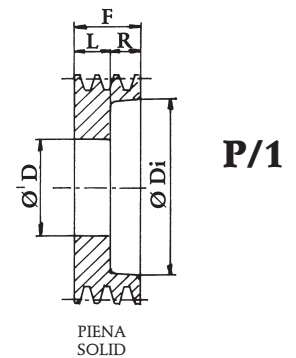
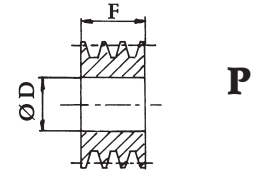



**PULEGGE A GOLE TRAPEZOIDALI  
PER CALETTATORI - FOR LOCKING ASSEMBLIES**

SEZIONE **SPA**

Dp	N° GOLE	FORMA	Ø DH8			F	L	Ø M	R	Ø Di	S
			Ø 55	Ø 65	Ø 80						
300	1	R	55	65	80	20	20	130		267	14
	2	R	55	65	80	35	27	130	4	267	14
	3	R	55	65	80	50	27	130	11,5	267	14
	4	R		65	80	65	27	130	19	267	14
	5	R		65	80	80	27	130	26,5	267	14
315	1	R	55	65	80	20	20	130		282	14
	2	R	55	65	80	35	27	130	4	282	14
	3	R	55	65	80	50	27	130	11,5	282	14
	4	R		65	80	65	27	130	19	282	14
	5	R		65	80	80	27	130	26,5	282	16
355	1	R	55	65	80	20	20	130		317	14
	2	R	55	65	80	35	27	130	4	317	14
	3	R	55	65	80	50	27	130	11,5	317	14
	4	R		65	80	65	27	130	19	317	18
	5	R		65	80	80	27	130	26,5	317	20
380	1	R		65	80	20	20	130		347	14
	2	R		65	80	35	27	130	4	347	14
	3	R		65	80	50	27	130	11,5	347	14
	4	R		65	80	65	27	130	19	347	18
	5	R		65	80	80	27	130	26,5	347	20
400	1	R		65	80	20	20	130		367	14
	2	R		65	80	35	27	130	4	367	14
	3	R		65	80	50	27	130	11,5	367	16
	4	R		65	80	65	27	130	19	367	20
	5	R		65	80	80	27	130	26,5	367	24
425	1	R		65	80	20	20	130		392	14
	2	R		65	80	35	27	130	4	392	14
	3	R		65	80	50	27	130	11,5	392	16
	4	R		65	80	65	27	130	19	392	20
	5	R		65	80	80	27	130	26,5	392	24
450	1	R		65	80	20	20	130		417	14
	2	R		65	80	35	27	130	4	417	14
	3	R		65	80	50	27	130	11,5	417	16
	4	R		65	80	65	27	130	19	417	20
	5	R		65	80	80	27	130	26,5	417	24
500	1	R		65	80	20	20	130		467	14
	2	R		65	80	35	27	130	4	467	16
	3	R		65	80	50	27	130	11,5	467	20
	4	R		65	80	65	27	130	19	467	25
	5	R		65	80	80	27	130	26,5	467	25
630	1	R		65	80	20	20	130		597	16
	2	R		65	80	35	27	130	4	597	20
	3	R		65	80	50	27	130	11,5	597	22
	4	R		65	80	65	27	130	19	597	25
	5	R		65	80	80	27	130	26,5	597	25

FORME COSTRUTTIVE  
CONSTRUCTION SHAPES

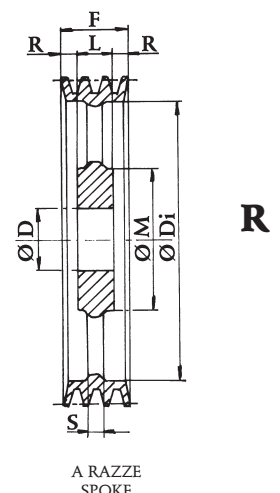
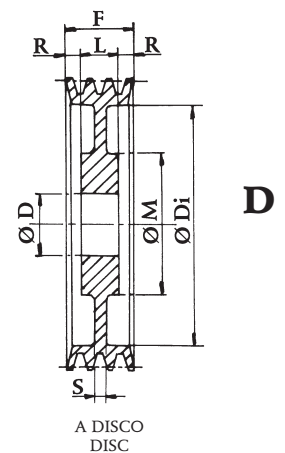
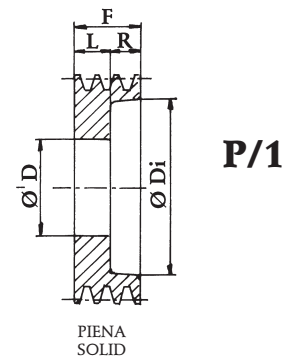
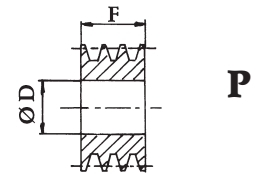

**PULEGGE A GOLE TRAPEZOIDALI  
PER CALETTATORI - FOR LOCKING ASSEMBLIES**

SEZIONE **SPB**

Dp	N° GOLE	FORMA	Ø DH8			F	L	Ø M	R	Ø Di	S
			Ø 55	Ø 65	Ø 80						
90	1	P	55			25					
	2	P	55			44	27				
	3	P	55			63	27				
	4	P	55			82	27				
	5	P	55			101	27				
105	1	P	55			25					
	2	P/1	55			44	27	17	65		
	3	P/1	55			63	27	36	65		
	4	P/1	55			82	27	55	65		
	5	P/1	55			101	27	74	65		
112	1	P	55			25					
	2	P/1	55			44	27	17	70		
	3	P/1	55			63	27	36	70		
	4	P/1	55			82	27	55	70		
	5	P/1	55			101	27	74	70		
120	1	P	55	65		25					
	2	P/1	55	65		44	27	17	78		
	3	P/1	55	65		63	27	36	78		
	4	P/1	55	65		82	27	55	78		
	5	P/1	55	65		101	27	74	78		
125	1	P	55	65		25					
	2	P/1	55	65		44	27	17	83		
	3	P/1	55	65		63	27	36	83		
	4	P/1	55	65		82	27	55	83		
	5	P/1	55	65		101	27	74	83		
130	1	P	55	65	80	25					
	2	P/1	55	65	80	44	27	17	90		
	3	P/1	55	65	80	63	27	36	90		
	4	P/1	55	65	80	82	27	55	90		
	5	P/1	55	65	80	101	27	74	90		
140	1	P	55	65	80	25					
	2	P/1	55	65	80	44	27	17	98		
	3	P/1	55	65	80	63	27	36	98		
	4	P/1	55	65	80	82	27	55	98		
	5	P/1	55	65	80	101	27	74	98		
150	1	P	55	65	80	25					
	2	P/1	55	65	80	44	27	17	108		
	3	P/1	55	65	80	63	27	36	108		
	4	P/1	55	65	80	82	27	55	108		
	5	P/1	55	65	80	101	27	74	108		
160	1	P	55	65	80	25					
	2	P/1	55	65	80	44	27	17	118		
	3	P/1	55	65	80	63	27	36	118		
	4	P/1	55	65	80	82	27	55	118		
	5	P/1	55	65	80	101	27	74	118		

FORME COSTRUTTIVE  
CONSTRUCTION SHAPES

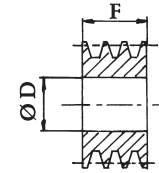

**P**

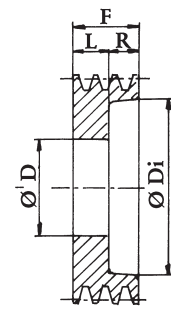

**P/1**

PIENA  
SOLID

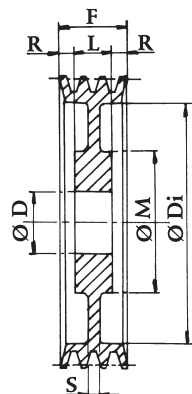

**D**

A DISCO  
DISC

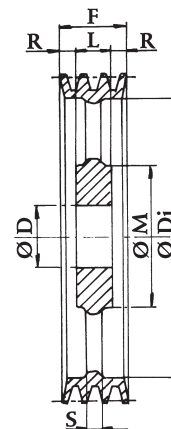

**R**

A RAZZE  
SPOKE

**PULEGGE A GOLE TRAPEZOIDALI  
PER CALETTATORI - FOR LOCKING ASSEMBLIES**

SEZIONE **SPB**

Dp	N° GOLE	FORMA	Ø DH8			F	L	Ø M	R	Ø Di	S
			Ø 55	Ø 65	Ø 80						
170	1	P	55	65	80	25					
	2	D	55	65	80	44	27		8,5	128	27
	3	D	55	65	80	63	27		18	128	27
	4	D	55	65	80	82	27		27,5	128	27
	5	D	55	65	80	101	27		37	128	27
180	1	P	55	65	80	25					
	2	D	55	65	80	44	27		8,5	138	27
	3	D	55	65	80	63	27		18	138	27
	4	D	55	65	80	82	27		27,5	138	27
	5	D	55	65	80	101	27		37	138	27
190	1	P	55	65	80	25					
	2	D	55	65	80	44	27		8,5	148	27
	3	D	55	65	80	63	27		18	148	27
	4	D	55	65	80	82	27		27,5	148	27
	5	D	55	65	80	101	27		37	148	27
200	1	P	55	65	80	25					
	2	D	55	65	80	44	27	120	8,5	158	15
	3	D	55	65	80	63	27	120	18	158	15
	4	D	55	65	80	82	27	120	27,5	158	15
	5	D	55	65	80	101	27	120	37	158	15
	6	D	55	65	80	120	27	120	46,5	158	18
212	1	D	55	65	80	25	25	120		170	15
	2	D	55	65	80	44	27	120	8,5	170	15
	3	D	55	65	80	63	27	120	18	170	15
	4	D		65	80	82	27	120	27,5	170	15
	5	D		65	80	101	27	120	37	170	15
225	1	D	55	65	80	25	25	120		183	15
	2	D	55	65	80	44	27	120	8,5	183	15
	3	D	55	65	80	63	27	120	18	183	15
	4	D		65	80	82	27	120	27,5	183	15
	5	D		65	80	101	27	120	37	183	15
	6	D		65	80	120	27	120	46,5	183	18
240	1	D	55	65	80	25	25	120		198	16
	2	D	55	65	80	44	27	120	8,5	198	16
	3	D	55	65	80	63	27	120	18	198	16
	4	D		65	80	82	27	120	27,5	198	16
	5	D		65	80	101	27	130	37	198	16
250	1	D	55	65	80	25	25	120		208	16
	2	D	55	65	80	44	27	120	8,5	208	16
	3	D	55	65	80	63	27	120	18	208	16
	4	D		65	80	82	27	120	27,5	208	16
	5	D		65	80	101	27	130	37	208	16
	6	D		65	80	120	27	130	46,5	208	18

FORME COSTRUTTIVE  
CONSTRUCTION SHAPES

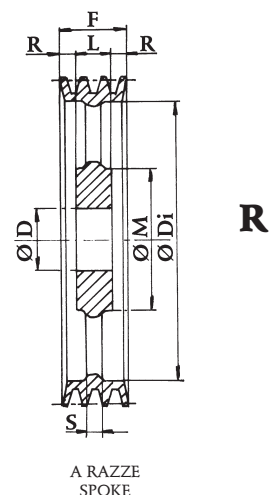
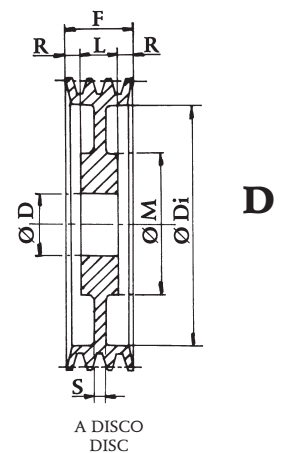
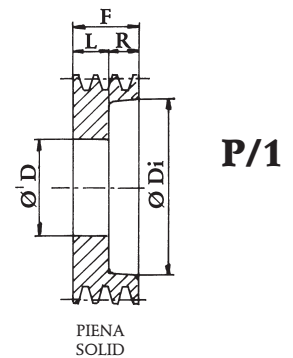
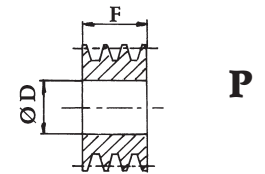

**PULEGGE A GOLE TRAPEZOIDALI  
PER CALETTATORI - FOR LOCKING ASSEMBLIES**

SEZIONE **SPB**

Dp	N° GOLE	FORMA	Ø DH8			F	L	Ø M	R	Ø Di	S
			Ø 55	Ø 65	Ø 80						
280	1	D	55	65	80	25	25	120		238	16
	2	D	55	65	80	44	27	120	8,5	238	16
	3	D		65	80	63	27	120	18	238	16
	4	D		65	80	82	27	120	27,5	238	16
	5	D		65	80	101	27	130	37	238	16
300	1	R	55	65	80	25	25	130		258	15
	2	R	55	65	80	44	27	130	8,5	258	15
	3	R		65	80	63	27	130	18	258	18
	4	R		65	80	82	27	130	27,5	258	20
	5	R		65	80	101	27	130	37	258	22
315	1	R	55	65	80	25	25	130		273	15
	2	R	55	65	80	44	27	130	8,5	273	15
	3	R		65	80	63	27	130	18	273	18
	4	R		65	80	82	27	130	27,5	273	20
	5	R		65	80	101	27	130	37	273	22
355	1	R	55	65	80	25	25	130		308	16
	2	R		65	80	44	27	130	8,5	308	18
	3	R		65	80	63	27	130	18	308	22
	4	R		65	80	82	27	130	27,5	308	22
	5	R		65	80	101	27	130	37	308	24
380	1	R		65	80	25	25	130		338	20
	2	R		65	80	44	27	130	8,5	338	20
	3	R		65	80	63	27	130	18	338	22
	4	R		65	80	82	27	130	27,5	338	24
	5	R		65	80	101	27	130	37	338	24
400	1	R		65	80	25	25	130		358	20
	2	R		65	80	44	27	130	8,5	358	20
	3	R		65	80	63	27	130	18	358	22
	4	R		65	80	82	27	130	27,5	358	24
	5	R		65	80	101	27	130	37	358	24
425	1	R		65	80	25	25	130		383	22
	2	R		65	80	44	27	130	8,5	383	22
	3	R		65	80	63	27	130	18	383	24
	4	R		65	80	82	27	130	27,5	383	24
	5	R		65	80	101	27	130	37	383	24
450	1	R		65	80	25	25	130		408	20
	2	R		65	80	44	27	130	8,5	408	20
	3	R		65	80	63	27	130	18	408	24
	4	R		65	80	82	27	130	27,5	408	24
	5	R		65	80	101	27	130	37	408	24
500	1	R		65	80	25	25	130		458	20
	2	R		65	80	44	27	130	8,5	458	20
	3	R		65	80	63	27	130	18	458	24
	4	R		65	80	82	27	130	27,5	458	24
	5	R		65	80	101	27	130	37	458	24

FORME COSTRUTTIVE  
CONSTRUCTION SHAPES

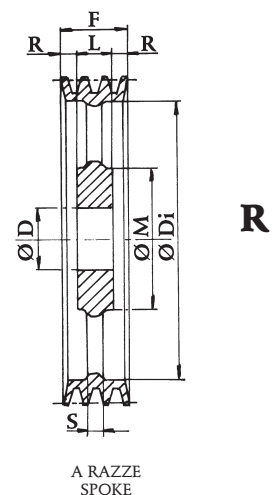
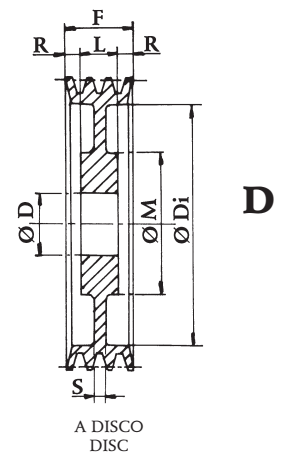
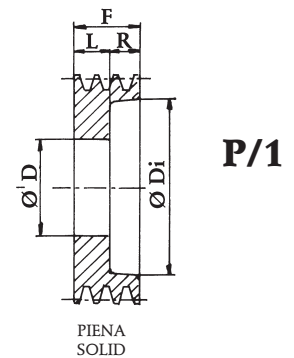
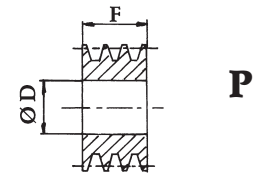

**PULEGGE A GOLE TRAPEZOIDALI  
PER CALETTATORI - FOR LOCKING ASSEMBLIES**

SEZIONE **SPC**

Dp	N° GOLE	FORMA	Ø DH8			F	L	Ø M	R	Ø Di	S
			Ø 55	Ø 65	Ø 80						
130	1	P/1	55	65		34	25		9	75	
	2	P/1	55	65		59,5	27		32,5	75	
	3	P/1	55	65		85	27		58	75	
	4	P/1	55	65		111	27		83,5	75	
	5	P/1	55	65		136	27		109	75	
140	1	P/1	55	65		34	25		9	83	
	2	P/1	55	65		59,5	27		32,5	83	
	3	P/1	55	65		85	27		58	83	
	4	P/1	55	65		111	27		83,5	83	
	5	P/1	55	65		136	27		109	83	
150	1	P/1	55	65	80	34	25		9	93	
	2	P/1	55	65	80	59,5	27		32,5	93	
	3	P/1	55	65	80	85	27		58	93	
	4	P/1	55	65	80	111	27		83,5	93	
	5	P/1	55	65	80	136	27		109	93	
160	1	P/1	55	65	80	34	25		9	103	
	2	P/1	55	65	80	59,5	27		32,5	103	
	3	P/1	55	65	80	85	27		58	103	
	4	D	55	65	80	111	27		42	103	
	5	D	55	65	80	136	27		54,5	103	
170	1	P/1	55	65	80	34	25		9	113	
	2	P/1	55	65	80	59,5	27		32,5	113	
	3	P/1	55	65	80	85	27		58	113	
	4	D	55	65	80	111	27		42	113	
	5	D	55	65	80	136	27		54,5	113	
180	1	P/1	55	65	80	34	25		9	123	
	2	P/1	55	65	80	59,5	27		32,5	123	
	3	P/1	55	65	80	85	27		58	123	
	4	D	55	65	80	111	27		42	123	
	5	D	55	65	80	136	27		54,5	123	
190	1	P/1	55	65	80	34	25		9	133	
	2	P/1	55	65	80	59,5	27		32,5	133	
	3	P/1	55	65	80	85	27		58	133	
	4	D	55	65	80	111	27		42	133	
	5	D	55	65	80	136	27		54,5	133	
200	1	P/1	55	65	80	34	25		9	143	
	2	P/1	55	65	80	59,5	27		32,5	143	
	3	P/1	55	65	80	85	27		58	143	
	4	D	55	65	80	111	27		42	143	
	5	D	55	65	80	136	27		54,5	143	
225	1	D		65	80	34	25	120	4,5	168	18
	2	D		65	80	59,5	27	120	16,5	168	18
	3	D		65	80	85	27	120	29	168	25
	4	D		65	80	111	27	130	42	168	25
	5	D		65	80	136	27	130	54,5	168	25

FORME COSTRUTTIVE  
CONSTRUCTION SHAPES

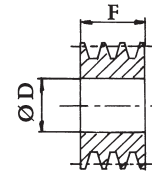

**P**

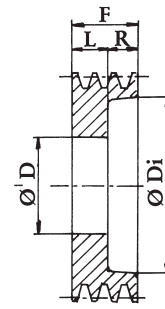

**P/1**

PIENA  
SOLID

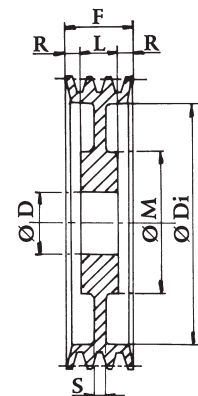

**D**

A DISCO  
DISC

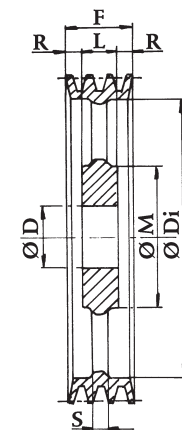

**R**

A RAZZE  
SPOKE

**PULEGGE A GOLE TRAPEZOIDALI  
PER CALETTATORI - FOR LOCKING ASSEMBLIES**
**SEZIONE SPC**

Dp	N° GOLE	FORMA	Ø DH8			F	L	Ø M	R	Ø Di	S
			Ø 55	Ø 65	Ø 80						
250	1	D		65	80	34	25	120	4,5	193	18
	2	D		65	80	59,5	27	120	16,5	193	18
	3	D		65	80	85	27	120	29	193	25
	4	D		65	80	111	27	130	42	193	25
	5	D		65	80	136	27	130	54,5	193	25
280	1	D		65	80	34	27	120	3,5	223	18
	2	D		65	80	59,5	27	120	16,5	223	18
	3	D		65	80	85	27	120	29	223	25
	4	D		65	80	111	27	130	42	223	25
	5	D		65	80	136	27	130	54,5	223	25
300	1	D		65	80	34	27	120	3,5	243	20
	2	D		65	80	59,5	27	120	16,5	243	20
	3	D		65	80	85	27	120	29	243	25
	4	D		65	80	111	27	130	42	243	25
	5	D		65	80	136	27	130	54,5	243	25
315	1	R		65	80	34	27	130	3,5	258	20
	2	R		65	80	59,5	27	130	16,5	258	20
	3	R		65	80	85	27	130	29	258	25
	4	R		65	80	111	27	130	42	258	25
	5	R		65	80	136	27	130	54,5	258	25
355	1	R		65	80	34	27	130	3,5	298	25
	2	R		65	80	59,5	27	130	16,5	298	25
	3	R		65	80	85	27	130	29	298	25
	4	R		65	80	111	27	130	42	298	25
	5	R		65	80	136	27	130	54,5	298	25
380	1	R		65	80	34	27	130	3,5	323	25
	2	R		65	80	59,5	27	130	16,5	323	25
	3	R		65	80	85	27	130	29	323	25
	4	R		65	80	111	27	130	42	323	25
	5	R		65	80	136	27	130	54,5	323	25
400	1	R		65	80	34	27	130	3,5	343	25
	2	R		65	80	59,5	27	130	16,5	343	25
	3	R		65	80	85	27	130	29	343	25
	4	R		65	80	111	27	130	42	343	25
	5	R		65	80	136	27	130	54,5	343	25
425	1	R		65	80	34	27	130	3,5	368	25
	2	R		65	80	59,5	27	130	16,5	368	25
	3	R		65	80	85	27	130	29	368	25
	4	R		65	80	111	27	130	42	368	25
	5	R		65	80	136	27	130	54,5	368	25
450	1	R		65	80	34	27	130	3,5	393	25
	2	R		65	80	59,5	27	130	16,5	393	25
	3	R		65	80	85	27	130	29	393	25
	4	R		65	80	111	27	130	42	393	25
	5	R		65	80	136	27	130	54,5	393	25
500	1	R		65	80	34	27	130	3,5	443	25
	2	R		65	80	59,5	27	130	16,5	443	25
	3	R		65	80	85	27	130	29	443	25
	4	R		65	80	111	27	130	42	443	25
	5	R		65	80	136	27	130	54,5	443	25

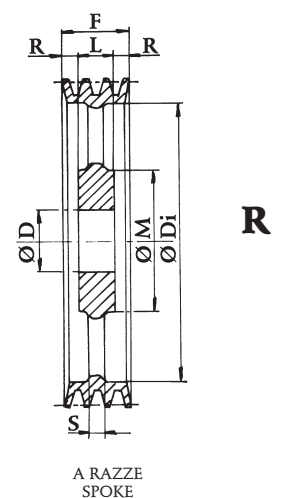
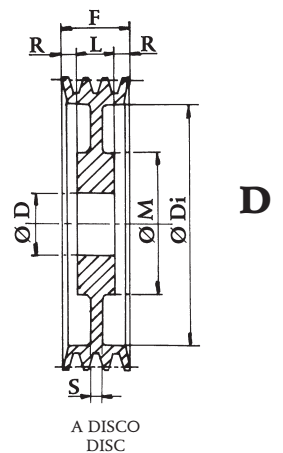
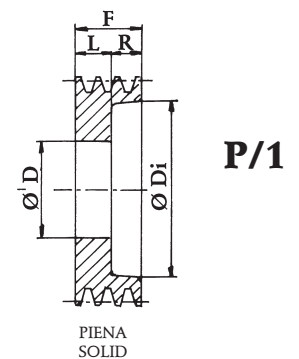
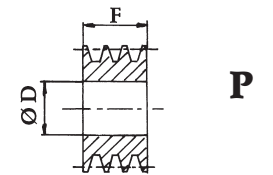
**FORME COSTRUTTIVE  
CONSTRUCTION SHAPES**

Le dimensioni riportate sulle tabelle dimensionali delle pulegge a gole trapezoidali con mozzo pieno sezioni SPA - SPB - SPC non sono impegnative anche se verranno rispettate nei limiti del possibile. Ci riserviamo la facoltà di apportare anche senza preavviso varianti e modifiche.

# PULEGGE REGOLABILI PER CINGHIE TRAPEZOIDALI PER BUSSOLA CONICA - FOR TAPER BUSH

foto

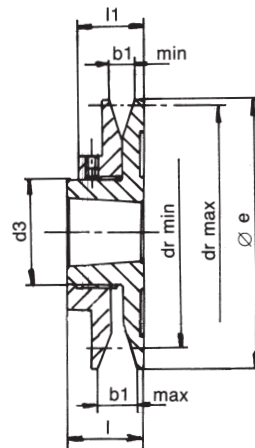

esecuzione 1

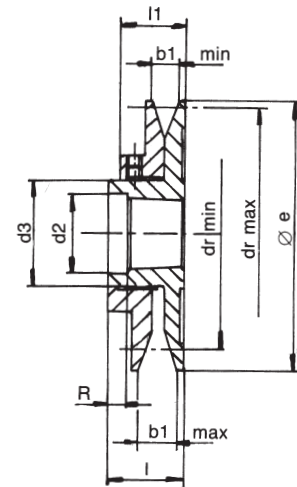

esecuzione 2

Materiale: **ACCIAIO C40**

TIPO PULEGGIA	Esecu- zione	N° Gole	BUSSOLA	Ø e	l	l <sub>1</sub>	b <sub>1</sub>		d <sub>r</sub>		d <sub>2</sub>	d <sub>3</sub>	R	Grani a coppa UNI 5929	SEZIONE CINGHIA	
							min	max	min	max						
<b>PRB-93</b>	2	1	1108	93	36,5	29	13	20,5	57 59	78 85	39	50	13,5	M6X6 N° 4	Z A	10x6 13x8
<b>PRB-108</b>	1	1	1215	108	38	30,5	13	20,5	68 70 75 76	92 100 93 102	-	60	-	M6x6 N° 4	Z A SPZ SPA	10x6 13x8
<b>PRB-120</b>	1	1	1215	120	38	30,5	13	20,5	80 82 87 88	104 112 105 114	-	60	-	M6x6 N° 4	Z A SPZ SPA	10x6 13x8
<b>PRB-138</b>	1	1	1615	138	38	30,5	13	20,5	98 100 105 106	122 130 123 132	-	74	-	M6x6 N° 4	Z A SPZ SPA	10x6 13x8
<b>PRB-160</b>	2	1	1615	160	45	35,5	17	26,5	108 112 114 117	138 150 140 153	58	74	6,5	M8x8 N° 4	A B SPA SPB	13x8 17x11
<b>PRB-180</b>	2	1	2012	180	45	35,5	17	26,5	128 132 134 137	158 170 160 173	71	90	12,5	M8x8 N° 4	A B SPA SPB	13x8 17x11
<b>PRB-200</b>	2	1	2012	200	45	35,5	17	26,5	149 152 155 159	177 190 179 193	71	90	12,5	M8x8 N° 4	A B SPA SPB	13x8 17x11

# PULEGGE REGOLABILI PER CINGHIE TRAPEZOIDALI PER BUSSOLA CONICA - FOR TAPER BUSH

foto

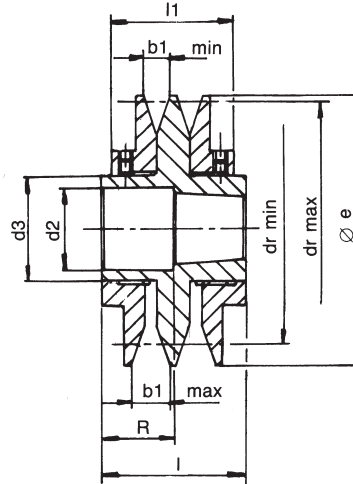

esecuzione 3

Materiale: **ACCIAIO C40**

TIPO PULEGGIA	Esecuzione	N° Gole	BUSSOLA	$\varnothing e$	l	$l_1$	$b_1$		$d_r$		$d_2$	$d_3$	R	Grani a coppa UNI 5929	SEZIONE CINGHIA
							min	max	min	max					
<b>PRB2-108</b>	3	2	1215	108	73	58	13	20,5	68	92	48,5	60	34,5	M6x6 N° 8	Z 10x6 A 13x8 SPZ SPA
									70	100					
									75	93					
									76	102					
<b>PRB2-120</b>	3	2	1215	120	73	58	13	20,5	80	104	48,5	60	34,5	M6x6 N° 8	Z 10x6 A 13x8 SPZ SPA
									82	112					
									87	105					
									88	114					
<b>PRB2-138</b>	3	2	1615	138	73	58	13	20,5	98	122	58,5	74	34,5	M6x6 N° 8	Z 10x6 A 13x8 SPZ SPA
									100	130					
									105	123					
									106	132					
<b>PRB2-160</b>	3	2	1615	160	87	68	17	26,5	108	138	58,5	74	48,5	M8x8 N° 8	A 13x8 B 17x11 SPA SPB
									112	150					
									114	140					
									117	153					
<b>PRB2-180</b>	3	2	2012	180	87	68	17	26,5	128	158	71	90	54	M8x8 N° 8	A 13x8 B 17x11 SPA SPB
									132	170					
									134	160					
									137	173					
<b>PRB2-200</b>	3	2	2012	200	87	68	17	26,5	149	177	71	90	54	M8x8 N° 8	A 13x8 B 17x11 SPA SPB
									152	190					
									155	179					
									159	193					



**PULEGGE PER CINGHIE SCANALATE POLY-V TAPER-LOCK®**  
**POLY-V BELT PULLEYS FOR TAPER BUSHES**

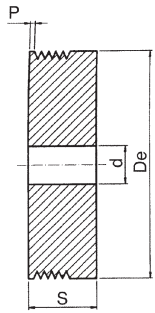

**Esecuzione 1**

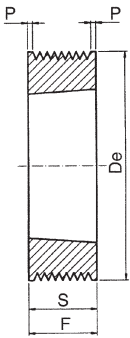

**Esecuzione 2**

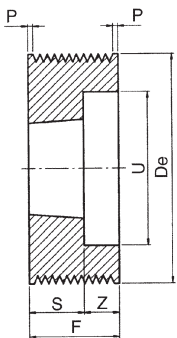

**Esecuzione 3**

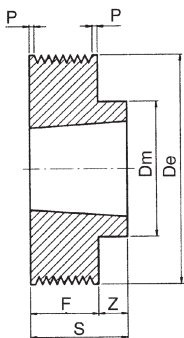

**Esecuzione 4**

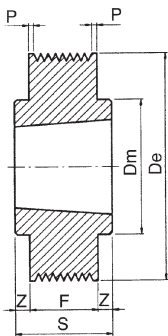

**Esecuzione 5**

**Sezione PPV-J**

De	Gole N.	Bussola	Esec.	S	Z	Dm	U	d
40	8	-	1	32	-	-	-	12
	12	-	1	41,5	-	-	-	12
	16	-	1	51	-	-	-	12
45	8	-	1	32	-	-	-	12
	12	-	1	41,5	-	-	-	12
	16	-	1	51	-	-	-	12
50	8	-	1	32	-	-	-	12
	12	-	1	41,5	-	-	-	12
	16	-	1	51	-	-	-	12
56	8	1108	2	23	-	-	-	-
	12	-	1	41,5	-	-	-	12
	16	-	1	51	-	-	-	12
63	8	1108	2	23	-	-	-	-
	12	1108	3	23	9,5	-	46	-
	16	-	1	51	-	-	-	12
71	8	1108	2	23	-	-	-	-
	12	1108	3	23	9,5	-	46	-
	16	1215	2	42	-	-	55	-
75	8	1108	2	23	-	-	-	-
	12	1610	3	26	6,5	-	60	-
	16	1610	3	26	16	-	60	-
80	8	1610	4	26	3	70	-	-
	12	1610	3	26	6,5	-	60	-
	16	1610	3	26	16	-	60	-
85	8	1610	4	26	3	70	-	-
	12	1610	3	26	6,5	-	60	-
	16	1610	3	26	16	-	60	-
90	8	1610	4	26	3	70	-	-
	12	1610	3	26	6,5	-	74	-
	16	1610	3	26	16	-	74	-

Gole N.	8	12	16
F ± 0,1	23	32,5	42
P	3,31	3,38	3,45

De	Gole N.	Bussola	Esec.	S	Z	Dm	U
95	8	1610	4	26	3	82	-
	12	1610	3	26	6,5	-	74
	16	1610	3	26	16	-	74
100	8	1610	4	26	3	82	-
	12	1610	3	26	6,5	-	74
	16	1610	3	26	16	-	74
106	8	1610	4	26	3	82	-
	12	1610	3	26	6,5	-	88
	16	1610	3	26	16	-	88
112	8	1610	4	26	3	90	-
	12	1610	3	26	6,5	-	88
	16	1610	3	26	16	-	88
118	8	1610	4	26	3	90	-
	12	2012	3	32	0,5	-	98
	16	2012	3	32	10	-	98
125	8	1610	4	26	3	90	-
	12	2012	3	32	0,5	-	98
	16	2012	3	32	10	-	98
132	8	1610	4	26	3	90	-
	12	2012	3	32	0,5	-	98
	16	2012	3	32	10	-	98
140	8	1610	4	26	3	90	-
	12	2517	4	45	12,5	120	-
	16	2517	4	45	3	120	-
160	8	2012	5	32	4,5	110	-
	12	2517	4	45	12,5	120	-
	16	2517	4	45	3	120	-
180	8	2012	5	32	4,5	110	-
	12	2517	5	45	6,25	120	-
	16	2517	5	45	1,5	120	-
200	8	2012	5	32	4,5	110	-
	12	2517	5	45	6,25	120	-
	16	2517	5	45	1,5	120	-
224	8	2012	5	32	4,5	110	-
	12	2517	5	45	6,25	120	-
	16	2517	5	45	1,5	120	-
250	8	2012	5	32	4,5	110	-
	12	2517	5	45	6,25	120	-
	16	2517	5	45	1,5	120	-

**PULEGGE PER CINGHIE SCANALATE POLY-V TAPER-LOCK®**  
**POLY-V BELT PULLEYS FOR TAPER BUSHES**

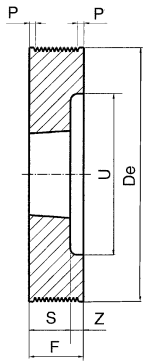

**Esecuzione 3**

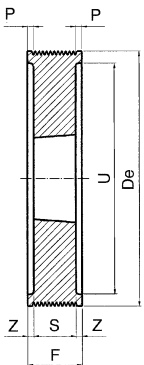

**Esecuzione 6**

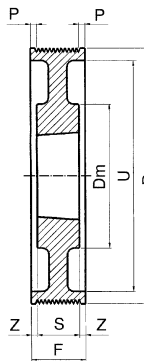

**Esecuzione 7**

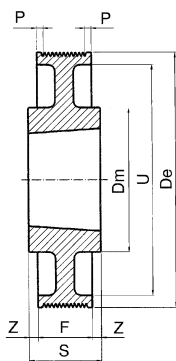

**Esecuzione 8**

**Sezione PPV-L**

De	Gole N.	Bussola	Esec.	S	Z	Dm	U
75	8	1210	3	26	22		56
	12	1215	3	42	25		56
80	8	1210	3	26	22		56
	12	1215	3	42	25		56
85	8	1210	3	26	22		61
	12	1215	3	42	25		61
	16	1215	6	42	22		61
90	8	1610	3	26	22		66
	12	1615	3	42	25		66
	16	1615	6	42	22		66
95	8	1610	3	26	22		71
	12	1615	3	42	35		71
	16	1615	6	42	27		71
100	8	1610	3	26	22		76
	12	2012	3	32	35		79
	16	2012	6	32	27		79
106	8	1610	3	26	22		82
	12	2012	3	32	35		82
	16	2012	6	32	27		82
112	8	1610	3	26	22		88
	12	2012	3	32	35		88
	16	2012	6	32	27		88
118	8	2012	3	32	16		94
	12	2517	6	45	11		97
	16	2517	6	45	20,5		97
125	8	2012	3	32	16		101
	12	2517	6	45	11		101
	16	2517	6	45	20,5		101
132	8	2012	3	32	16		108
	12	2517	6	45	11		108
	16	2517	6	45	20,5		108
140	8	2517	3	45	3		116
	12	2517	6	45	11		116
	16	2517	6	45	20,5		116
150	8	2517	3	45	3		126
	12	2517	6	45	11		126
	16	2517	6	45	20,5		126

De	Gole N.	Bussola	Esec.	S	Z	Dm	U
160	8	2517	3	45	3		136
	12	2517	6	45	11		136
	16	3020	6	52	17		136
170	8	2517	3	45	3		146
	12	2517	6	45	11		146
	16	3020	6	52	17		146
180	8	2517	7	45	1,5	120	156
	12	2517	7	45	11	120	156
	16	3020	6	52	17		156
200	8	2517	7	45	1,5	120	176
	12	3020	7	52	7,5	146	176
	16	3020	7	52	17	146	176
224	8	2517	7	45	1,5	120	202
	12	3020	7	52	7,5	146	202
	16	3020	7	52	17	146	202
250	8	3020	8	52	2	146	228
	12	3020	7	52	7,5	146	228
	16	3535	8	89	1,5	148	228
280	8	3020	8	52	2	146	256
	12	3020	7	52	7,5	146	256
	16	3535	8	89	1,5	148	256
315	8	3020	8	52	2	146	285
	12	3535	8	89	11	178	285
	16	3535	8	89	1,5	178	285

Gole N.	8	12	16
F± 0,1	48	67	86
P	7,55	7,65	7,75

## BUSSOLE CONICHE TAPER BUSHES

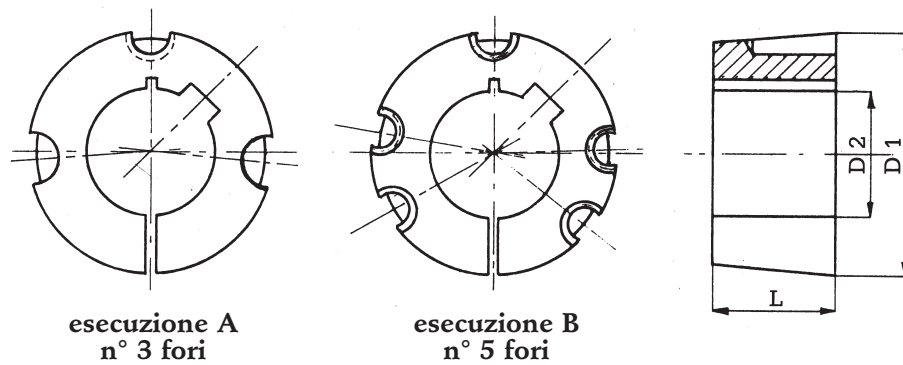

Riferimento N.	Esecuzione	L	D <sub>1</sub>	Fori D <sub>2</sub> <sup>Es</sup> (con cava per chiavetta secondo DIN 6885/1)	Viti B.S.W.	Coppia di serraggio in N/m
1008	A	22	35	10-12-14-16-18-19-20-22-24-25	1/4"x1/2"	5,6
1108	A	22	38	14-19-20-24-25-28-	1/4"x1/2"	5,6
1210	A	25	47,5	14-16-18-19-20-24-25-28-30-32	3/8"x5/8"	19,6
1215	A	38	47,5	14-19-20-24-25-28	3/8"x5/8"	19,6
1610	A	25	57	14-16-19-20-24-25-28-30-32-35-38-40-42	3/8"x5/8"	19,6
1615	A	38	57	19-20-22-24-25-28-30-32-35-38-40	3/8"x5/8"	19,6
2012	A	32	70	19-20-24-25-28-30-32-35-38-40-42-45-48-50	7/16"x7/8"	30,4
2517	A	45	85,5	19-20-24-25-28-30-32-35-38-40-42-45-48-50-55-60-65	1/2"x1"	48
3020	A	51	108	28-30-32-35-38-40-42-45-48-50-55-60-65-70-75	5/8"x1"1/4	90
3030	A	76	108	38-42-45-48-50-55-60	5/8"x1"1/2	90
3525	B	65	127	38-40-42-45-48-50-55-60-65-70-75-80	1/2"x1"1/2	113
3535	B	89	127	40-42-45-48-50-55-60-65-70-75-80-85-90	1/2"x1"1/2	113
4030	B	76	146	40-42-45-48-50-55-60-65-70-75-80-90	5/8"x1"1/2	169
4040	B	102	146	50-55-60-65-70-75-80-85-90-95	5/8"x1"3/4	169
4535	B	89	162	65-70-75-80-85-90-95-100-110-120-125	3/4"x2"	192
4545	B	115	162	65-70-75-80-85-90-95-100-110	3/4"x2"	192
5040	B	102	177,6	70-75-80-85-90-100-110-120-125	7/8"x2"1/4	272
5050	B	127	177,6	70-75-80-85-90-95-100-110-115-120-125	7/8"x2"1/4	272

Tutte le bussole coniche sono numerate usando un sistema internazionale che identifica velocemente diametro massimo del foro e la lunghezza del mozzo.

## ADATTATORI PER BUSSOLE CONICHE TAPER BUSHES ADAPTORS

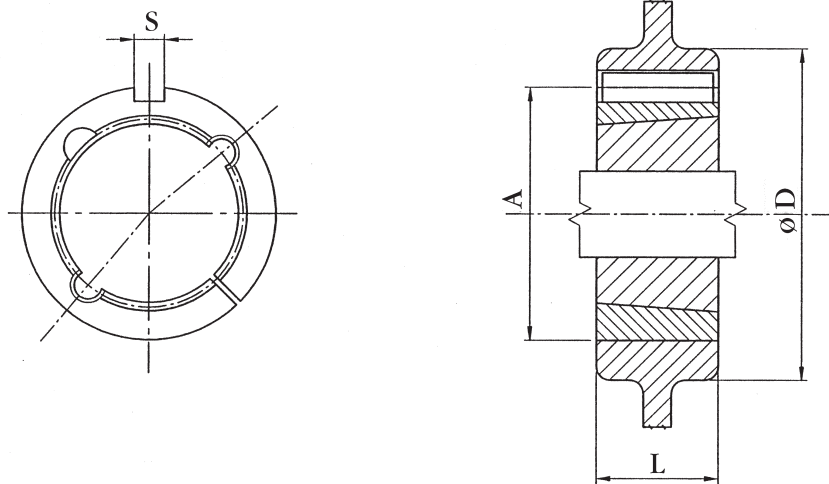

Riferimento adattatore	N° BUSSOLE	L	A	MOZZO ØD minimo		S
				Ghisa	Acciaio	
ARC 1008	1008	22	45	75	60	5 X 5
ARC 1210	1210	25	60	105	85	6 X 6
ARC 1610	1610	25	70	115	95	10 X 8
ARC 1615	1615	38	70	115	95	10 X 8
ARC 2517	2517	45	105	150	130	16 X 10
ARC 3030	3030	76	130	190	160	20 X 12
ARC 3535	3535	90	160	240	200	22 X 12
ARC 4040	4040	102	185	290	240	24 X 12



**Filiali italiane - deposit**

**R.C. TRASMISSIONI srl**

21020 BUGUGGIATE (MI)

Via Rasini, 13

Tel. 0332 457222 (rx.)

Fax 0332 890160

[www.rctrasmissioni.com](http://www.rctrasmissioni.com)

[informazioni@rctrasmissioni.com](mailto:informazioni@rctrasmissioni.com)

**35122 PADOVA**

Via Panigallo, 11 int. 73

Tel. 049 8705184 - Fax 049 8700037

**10148 TORINO**

Via G. B. Lulli, 61h

Tel. 011 2267146 - Fax 011 2266925

**20156 MILANO**

Via E. Cantoni, 3

Tel. 02 33400947 - Fax 02 33400949

**40011 BOLOGNA**

Via 1° Maggio, 10 - Anzola dell'Emilia

Tel. 051 735290 - Fax 051 735366

**R. C. TRASMISSIONI S.R.L.**